

DISPLAY UNIT

Four channel sensor display with touch screen control

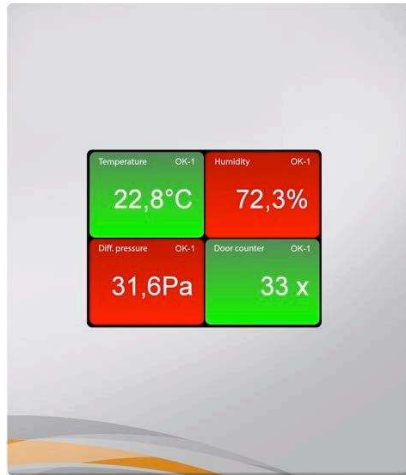

The Display Unit



The Display Unit is a module to display up to 4 sensor signals. Applications are laboratory experiments or experimental series.

- ∞ four sensor inputs, free programmable units (such as mW/cm², lux, °C, counts, Pa etc.)
- ∞ programming and calibration via touch screen or PC software
- ∞ programmable alarms – red coloured value and buzzer alarm, two programmable relays
- ∞ suited for cleanrooms

Specifications of the Display Unit

Parameter	Value	Unit
Ports		
Number of probe inputs (0...10VDC or (0)4...20mA)	4	-
Parameters of the housing		
Panel dimensions (BxH)	150 x 120	mm ²
Installation Dimensions	127 x 107 x 50	mm
Degree of protection, front side	IP65	-
Additional technical data		
Operating temperature	-10...+50	°C
Storage temperature	-10... +50	°C
Power supply	24	V _{AC} or V _{DC}
Power consumption at 24 VDC	0,12	W
Weight	0,240	kg

DISPLAY UNIT

Four channel sensor display with touch screen control



Display Examples



DISPLAY UNIT - USER MANUAL

TABLE OF CONTENTS

1. **Basic requirements and safety**
2. **Technical specifications**
3. **Wiring diagram**
4. **Jumper settings**
5. **Quick start**
6. **Operating procedure**
7. **Alarm**
8. **Counter**
9. **Menu Structure**
10. **Configuration check**

1. Basic Requirements and safety:



The manufacturer is not responsible for any damages caused by inappropriate installation, not maintaining the proper Technical condition and using the unit against its destination.

Installation should be conducted by qualified personal. During installation all available safety requirements should be considered. The fitter is responsible for executing the installation according to this manual, local safety and EMC regulations.

The unit must be properly set-up, according to the application. Incorrect configuration can cause defective operation, which can lead to unit damage or an accident.

If in the case of a defect of unit operation there is a risk of a serious threat to the safety of people or property additional, independent systems and Solutions to prevent such a threat must be used.

The unit uses dangerous voltage that can cause a lethal accident. The unit must be switched off and disconnected from the power supply prior to starting installation of troubleshooting (in case of malfunction).

Neighbouring and mating equipment must meet the requirements of appropriate standards and regulations. Concerning safety and be equipped with adequate anti-overvoltage and anti-interference filters.

Do not attempt to disassemble, repair or modify the unit yourself. The unit has no user serviceable parts. Units, in which a defect was stated must be disconnected and submitted for repair at an authorized service centre.



In order to minimize fire or electric shock hazard, the unit must be protected against atmospheric precipitation and excessive humidity.

Do not use the unit in areas threatened with excessive shocks, vibrations, dust, humidity, corrosive gasses and oils.

Do not use the unit in explosion hazard areas.

Do not use the unit in areas with significant temperature variations, exposed to condensation or icing

Do not use the unit in areas exposed to direct sunlight.

Make sure that the ambient temperature (e.g. inside the control box) does not exceed the recommended values. In such cases forced cooling of the unit must be considered (e.g. a ventilator)

The unit is designed for operation in a non industrial environment and must be used in this way.

2. Technical specifications:

Power supply	DC 24V+/- 20% of AC 24V +10% / -20%
Power consumption	12VA
Input impedance at mA	150 Ω
Input impedance at V	15 k Ω
Impedance digital input	3 k Ω
Display	3.5" TFT display with Touch screen
Protection class	Front IP65 / Wiring IP00
Dimensions	150 x 120 x 50 mm
Mounting hole	127 x 107 mm
Casing type	Panel, snap in
Ambient temperature	-10°C tot +50°C
Humidity	5% till 90% non-condensing
Analog input	0...10VDC , 0/4...20mA (via jumper selectable)
Digital input	logic 0 = 0-6V / logic 1 = 18-24V (max. 1000 Hz)
Wiring	Via connectors on the back
Input	4x Analog, 4x digital, RS485, Modbus RTU
Output	Relays (2x): 125VAC -0.5A 30Vac-1A 60VDC -0.3A /5msec RS-232 RS-485 +24VDC (2x) (max. 0.5A) +3.3VDC (max. 20mA)
Ethernet	Standard 10/100Mbaud
USB	Standard PC compatible
SD input	Micro SD, standard PC compatible
GND	Is used with power supply and inputs

The display can show 1 up to 4 inputs simultaneously (user selectable).

These inputs can independently generate visual and acoustic alarm.

At the visual alarm the background color will change from green (no alarm) to red (alarm), at an acoustic alarm a buzzer will sound (if switched ON).

The sound of the buzzer can be suppressed, while the background color will not change.

The digital inputs can be used as "door counter" via a 24V pulse (if necessary supplied by the unit {max. 0.5A}), alarms can be set as well.

The counter can count up to max. 9999 and can be reset to "Zero" manually.

All settings can be made via the touch screen, but you need to set the jumpers on the back to select the proper analog input (mA or V).

The unit has the possibility to display a status message, this can be done by activating a digital input and for example the message "Out of Service" will be displayed.

You can also select the background color and buzzer ON/OFF.

3. Wiring diagram:

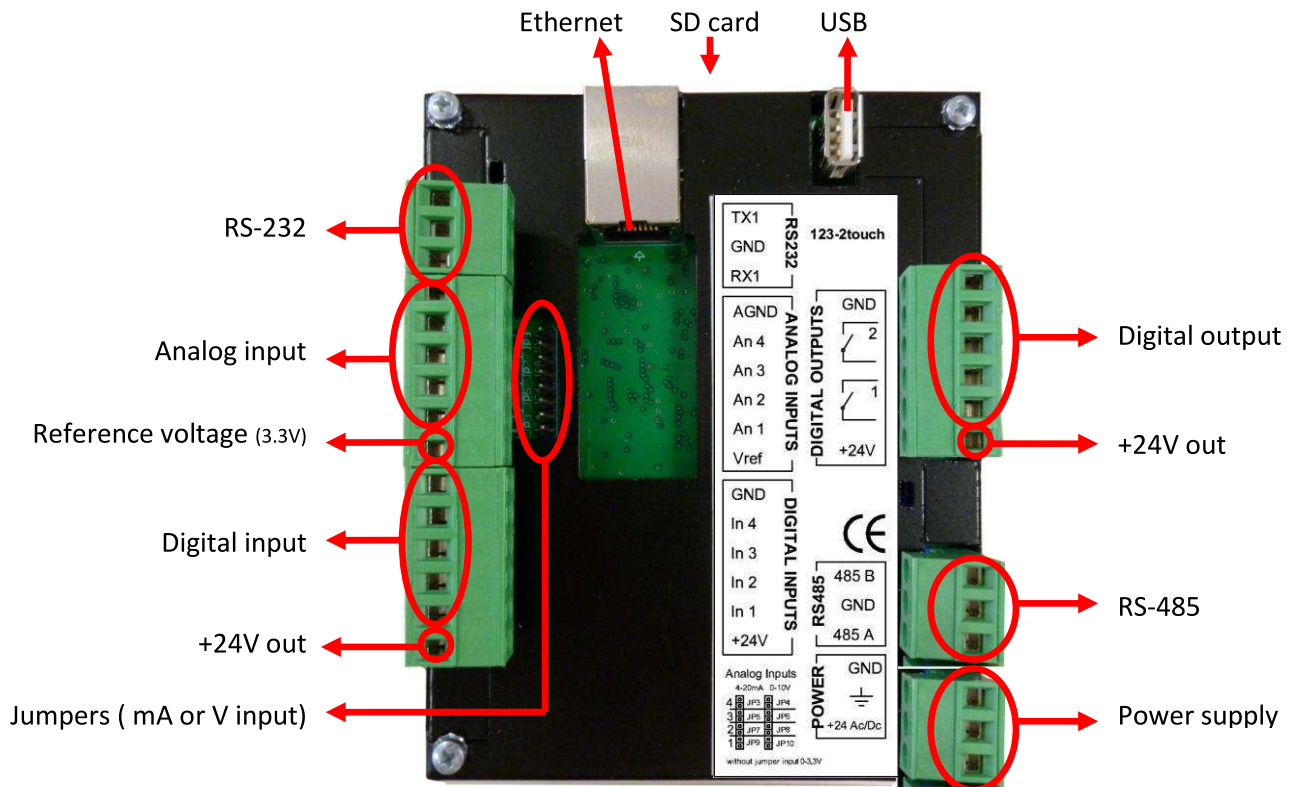

4. Jumper settings:

With these settings you can select **0...10VDC** or **(0)4...20mA** as analog input.

If no jumpers are set the input will be automatically 0...3.3V (Vref.)

- ⚠ These settings must be set in the “input type” menu as well
- ⚠ The jumpers ALWAYS must be set!!!
- ⚠ jumpers must be changed without power supply connected to the device !!!

Analog Inputs

4-20mA 0-10V

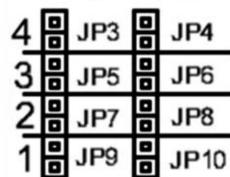

without jumper input 0-3,3V

5. Quick Start:

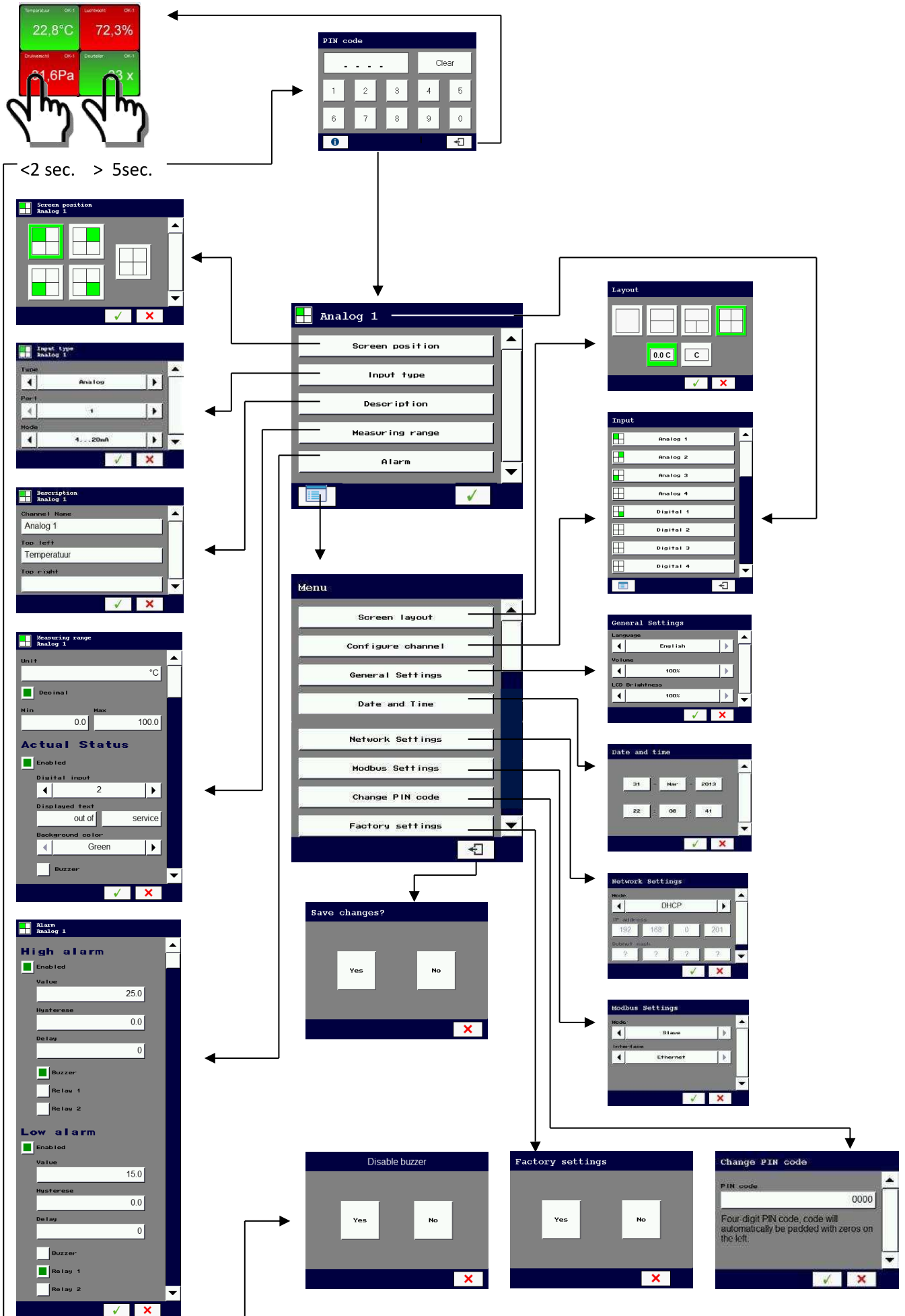

6. Operating procedure:

If the unit is connected to the power supply (24VDC/AC) the following screens will appear.

The data is collected from the SD card.

After the startup the unit automatically will show the measuring modus (standard 4 input screens)



By touching the screen for **minimal 5 sec.** the **PIN menu** will appear, where the standard PIN-code **“0000”** needs to be entered (PIN-code stays active for 1 minute)

The PIN-code can be changed via **“PIN change”** (in the main menu) into your own 4-digit code

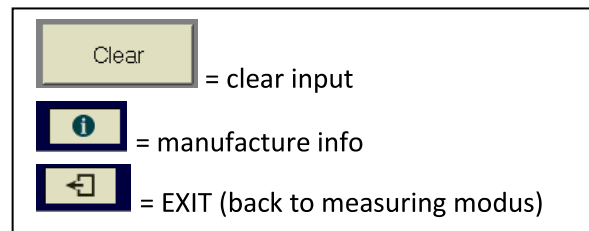
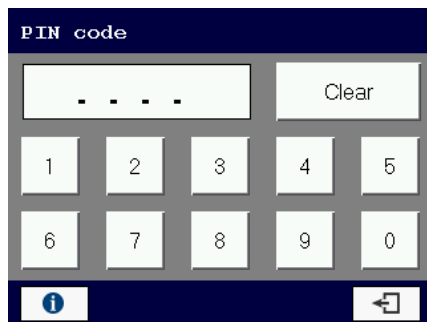

If the PIN-code is incorrect the code will appear in **RED**, try again.

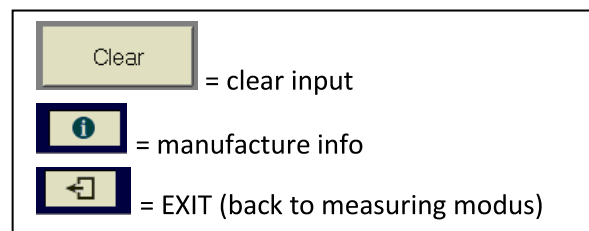

If no action is taken for **20 seconds** the unit will return to the measuring modus.

If the **PIN-code** is correct you automatically enter the input configuration of the screen that has been touched (in the example **Analog 1** is selected).

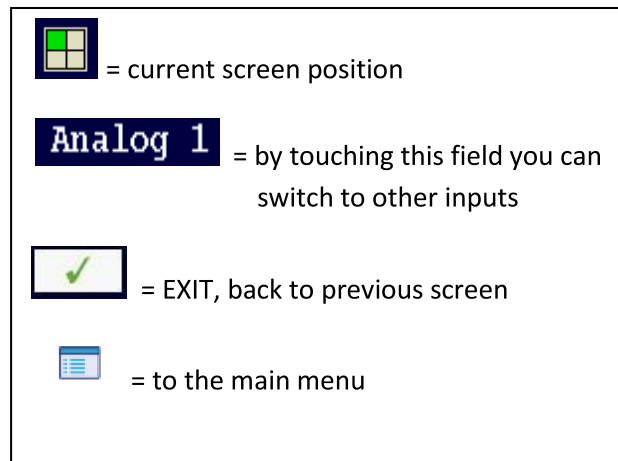
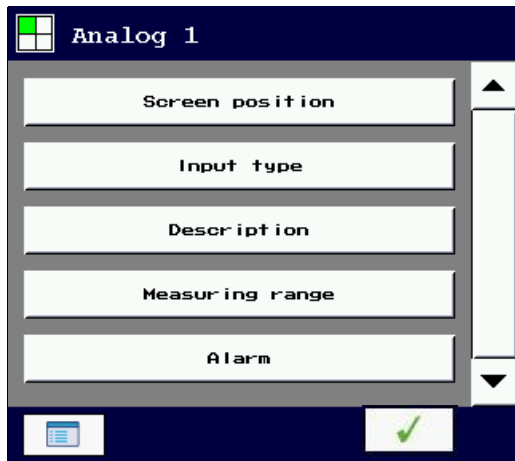

Screen layout: Where the selected input needs to be displayed.

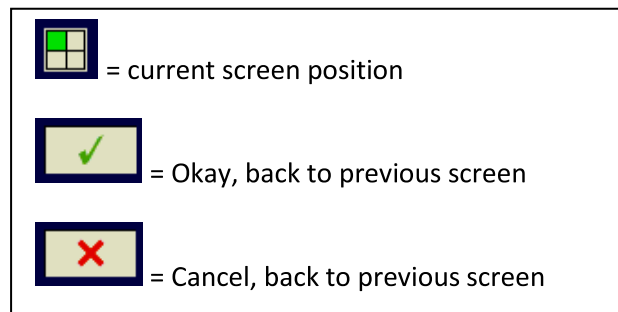
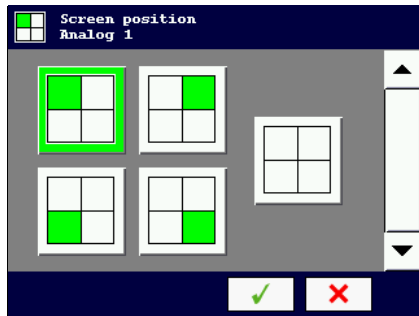

Input type: What input type is applied

Disabled: No input is required

Analog: (remind the **JUMPER** setting !!!)

Choose port number to be used,
and choose mode (raw value, 0..20mA, 4..20mA, 0..10VDC)

Digital:

Choose port number to be used

Modbus:

The input value is coming from a Modbus master module

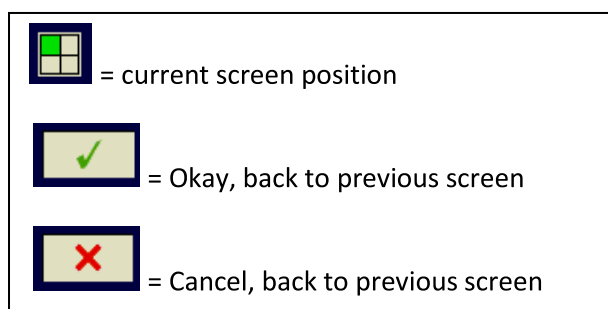

Description: Which text needs to be displayed **Top Left-** and **Top right** of the selected screen

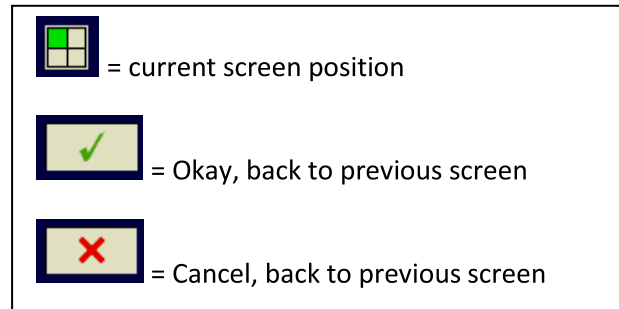
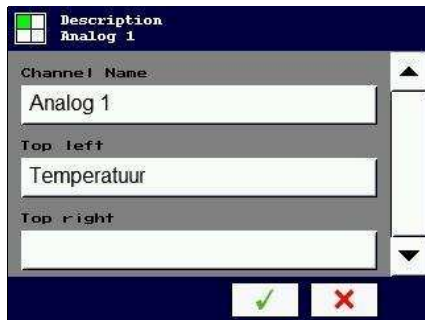

Measuring range: setting of minimum (**Min**) and maximum (**Max**) value, decimal point (Yes / No) and Unit (for example °C)

Actual Status: If for example digital input 4 is set, the text will be displayed (for example “out of service”)

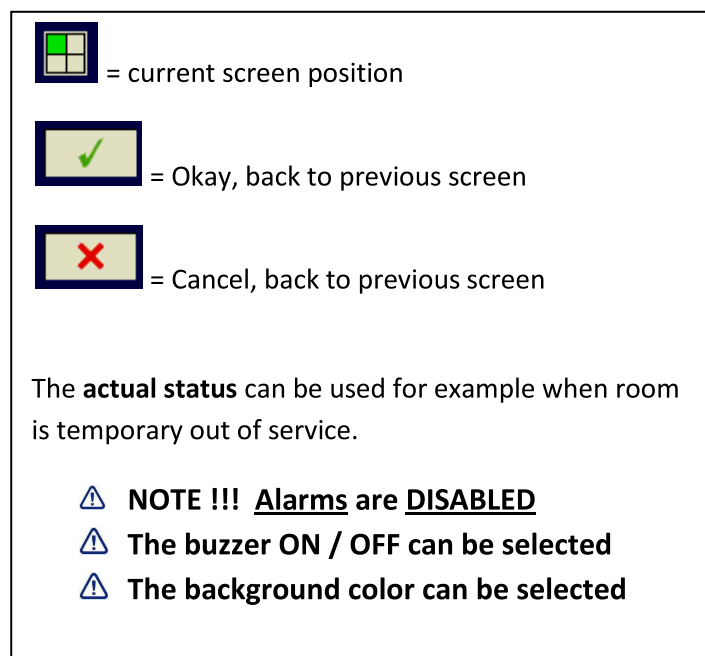
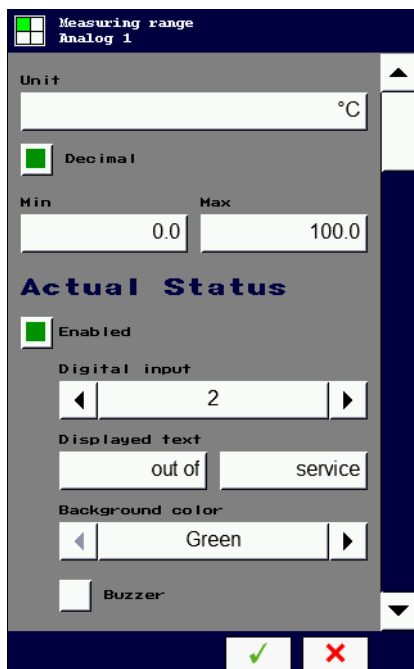

Alarm: setting of HIGH and LOW Alarm, Hysteresis, Delay , Buzzer en Relays

Alarm
Analog 1

High alarm

Enabled

Value

Hysteresis

Delay

Buzzer

Relay 1

Relay 2

Low alarm

Enabled

Value

Hysteresis

Delay

Buzzer

Relay 1

Relay 2

When all settings are done, touch  and you will enter the parent menu



= current screen position



= Okay, back to previous screen



= Cancel, back to previous screen

Enabled = alarm ON / OFF

Value = value at which the alarm is activated

Hysteresis = difference value between status change of the alarm

Delay = alarm delay in seconds

Buzzer = ON / OFF at alarm status

Relay 1/2 = ON / OFF at alarm status

NOTE 1 : If a **DIGITAL** input is selected:

- the "Input type" is **not** active
- At the "measuring range" the **unit** only can be set
- At the "Alarm" only the **High alarm** can be set



NOTE 2: If a **Modbus** input is selected:

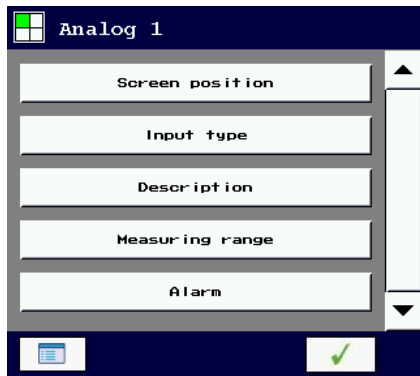

- A modbus failer alarm can be set in the same way as done by the low and high alarms.
- No value can be set
- No hysteresis can be set

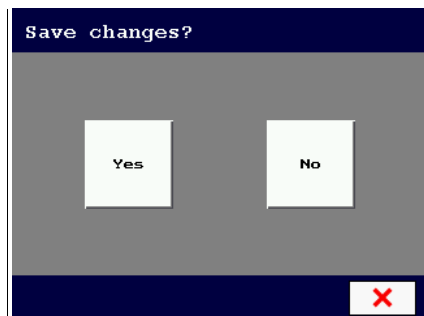

Touch  and the next screen will appear if changes have been done else you will return to the measuring mode.



	= save changes, back to measure modus
	= don't save changes, back to measure modus
	= Cancel, back to previous screen

If  is touched instead of  , than you will enter the `Main Menu` where further settings can be done, the previous setting will be saved after leaving the `Main Menu`.

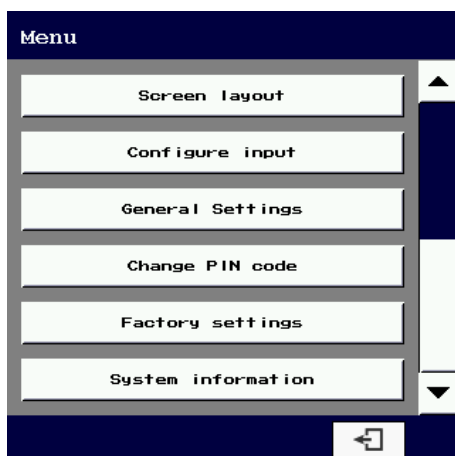

Screen Layout: normally the layout is depending on the amount of sensor connected, you can also choose if you want the **measured values (0.0 C)** or only **the unit (C)** to be displayed.

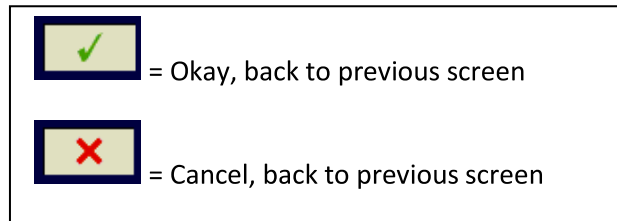
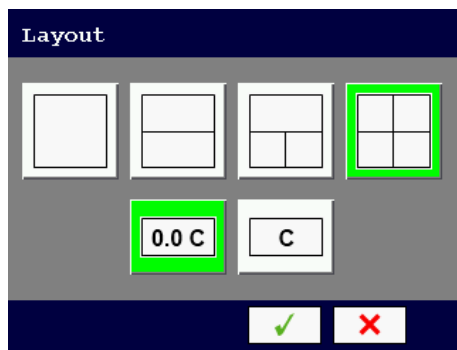

Configure Input: here you can choose which input you want to configure.

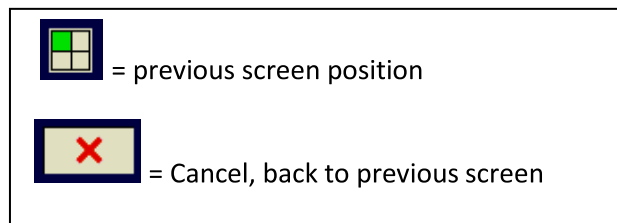
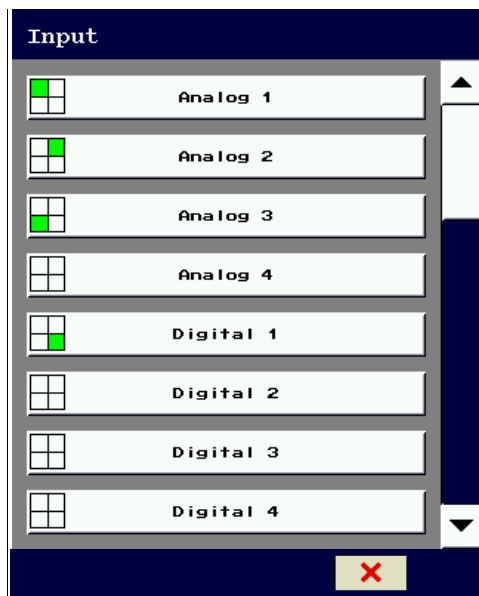

General settings:

- Device Name (usually it is called 123-2Touch along with the serial number of the devise)
- Language selection (Nederlands / Deutsch / English)
- Setting of the Buzzer volume (in steps of 20%)
- Setting of the LCD brightness (in steps of 10%)

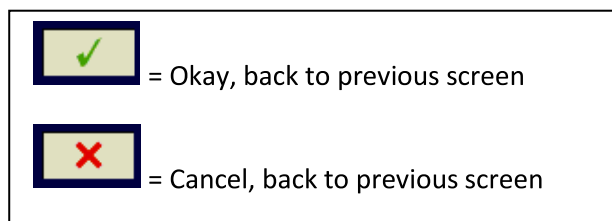
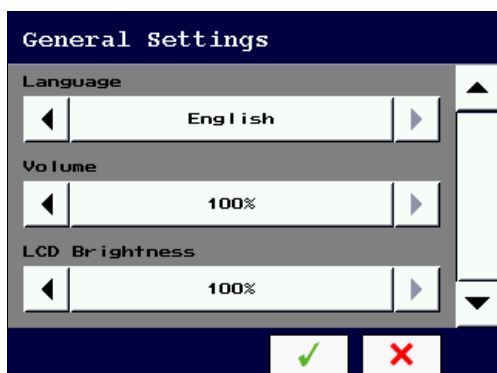

Date and Time:

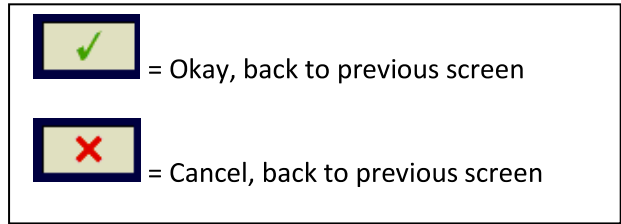
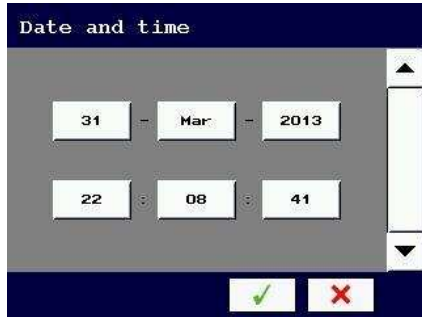

- each item can be changed by touching the desired field.
- when ready touch the green mark at the bottom.
- for undo touch the red cross

Network Settings (Only for Version 1.7.2 and up)

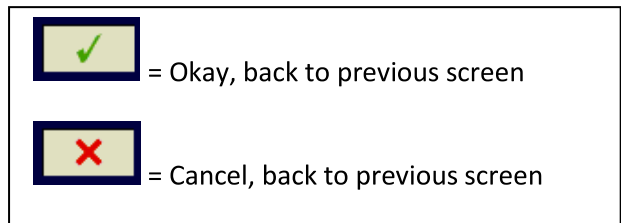
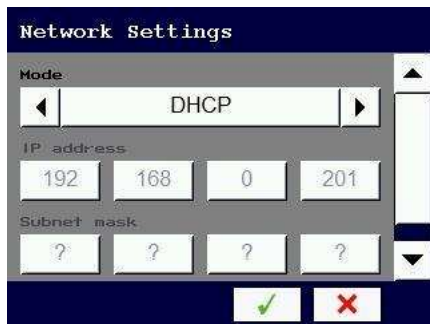

- The mode can be changed to DHCP or STATIC IP.
- at DHCP the unit will receive an IP number from the connected router
- at Static IP you can enter your own required IP address, Subnet mask and default gateway settings.

Modbus Settings (Only for Version 1.6.1 and up)

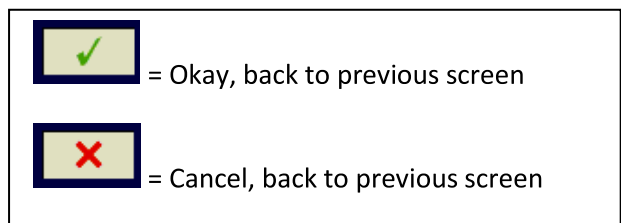
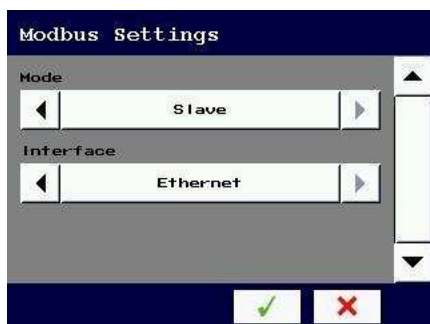

- The mode can be changed from disabled to Modbus Slave.
- The Interface can be selected as RS232 , RS485 or Ethernet, whereby at the RS232 and RS485 settings the required Baud rate and Address can be set.

Change PIN code: here you can change the PIN code a 4-digit PIN-code of your choice.

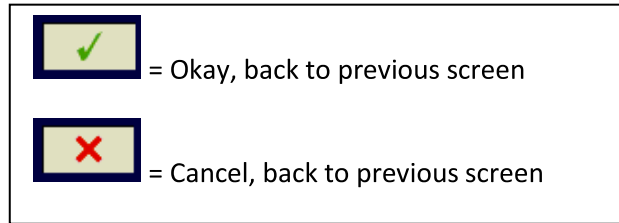
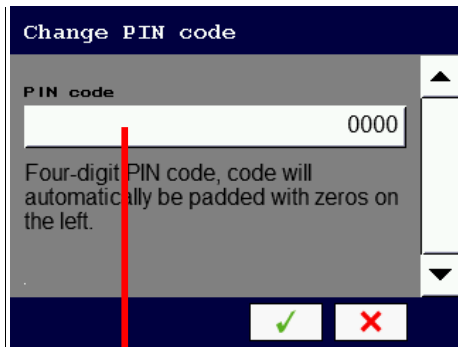

By touching the PIN code field you get the below screen for changing the PIN code

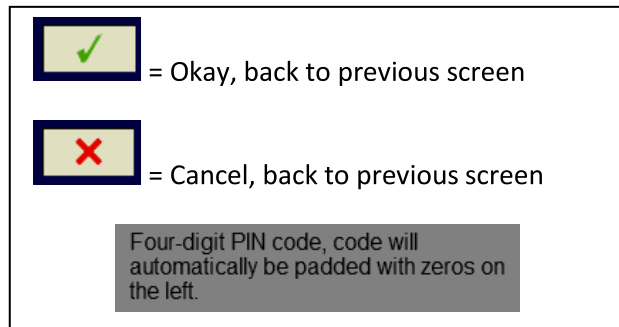
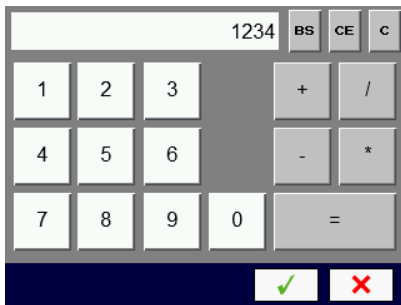

Factory settings: here you can go back to the standard factory settings.

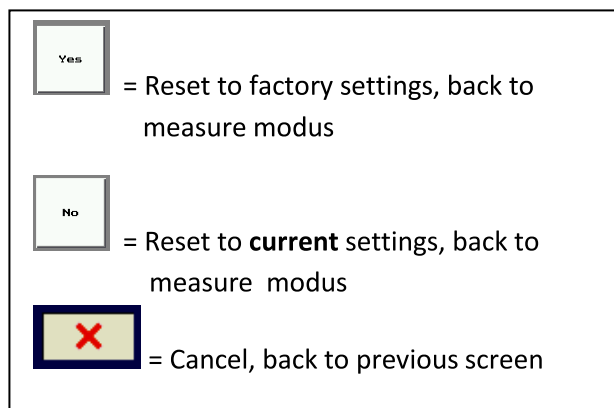
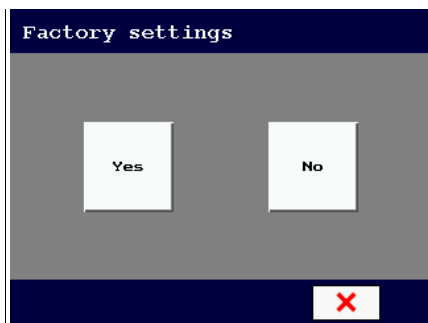

 Counters will be set back to "0"

System information: Here you find information about the manufacturer

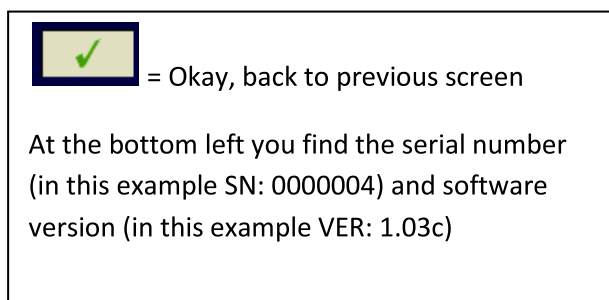

NOTE:

By touching the **numerical** or **Alfa numerical** field the next screens will appear.
(as example the "Measuring range" is chosen)

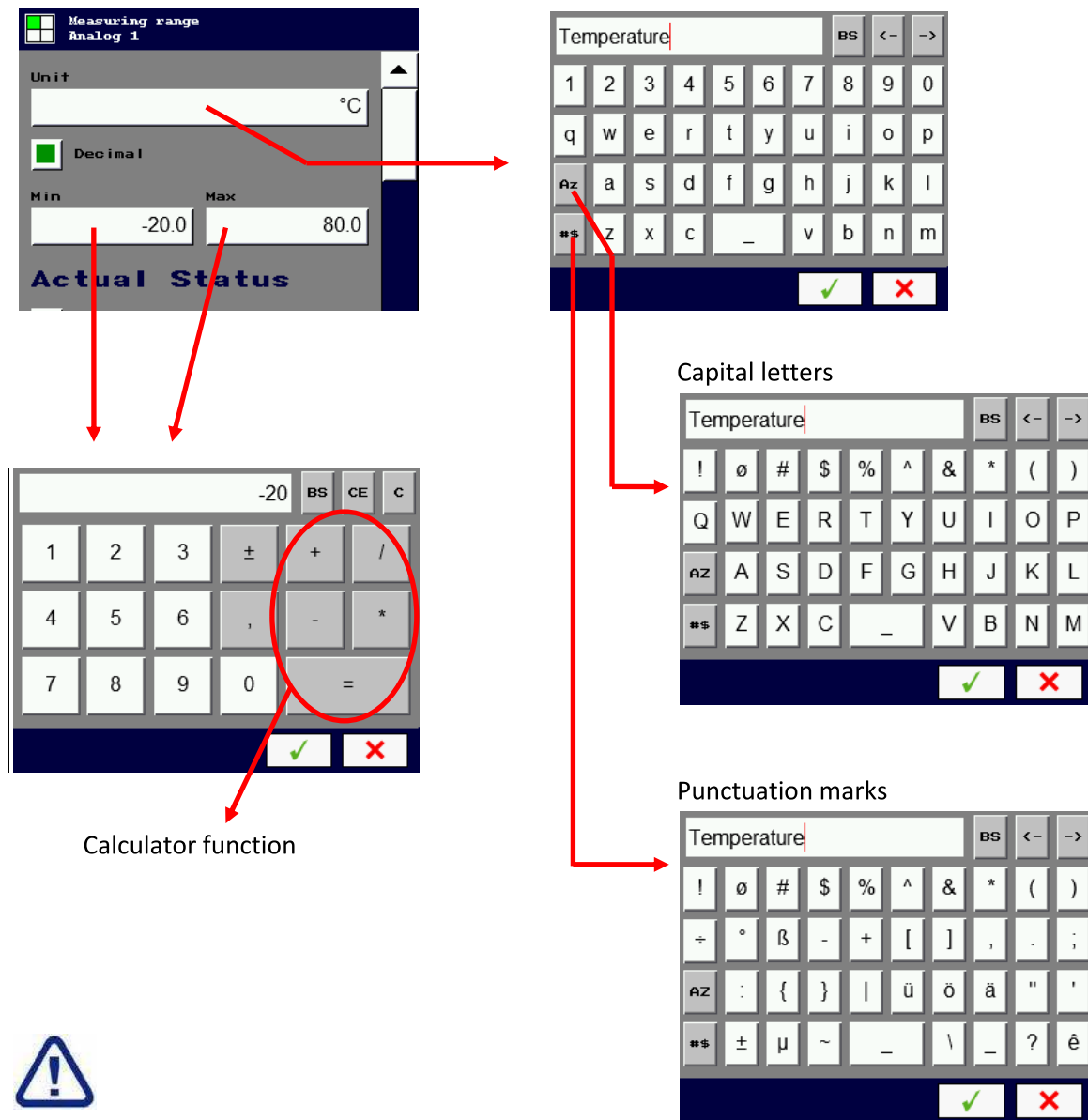

If during configuration the background of the input field turns **"RED"** the added value is not correct.

Example:

- the min. value is higher than the max. value
- the alarm limits are outside the measuring range

NOTE:



1x push = **SHIFT** function



2x push = **CAPS LOCK** function

7. Alarm:

If the measuring signal exceeds the set alarm limit the background color changes from “green” to “red”, the buzzer also will be activated (if switched ON).

If the measuring signal gets within the alarm limit the background color changes back to “green” and the buzzer will be deactivated.

During the alarm situation the buzzer can manually be deactivated by touching (< 2 sec.) the field in which the alarm has appeared, the below screen will appear.

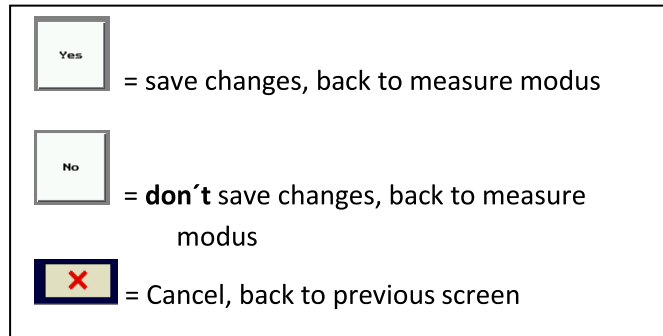
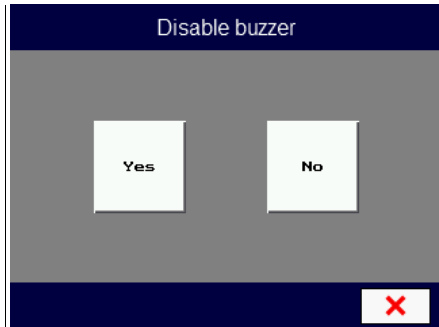

⚠ The background color stays “red” during alarm situations even when the buzzer is deactivated.

8. Counter:

The digital inputs can be used as door counter, every time the digital input gets a logical “high”, counts will be increased. By touching the “counter field” (< 2 sec.) the below screen will appear.

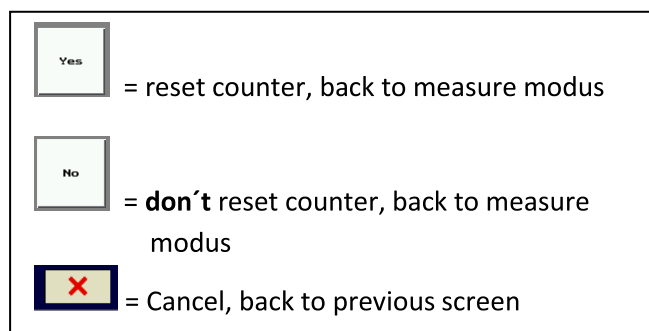
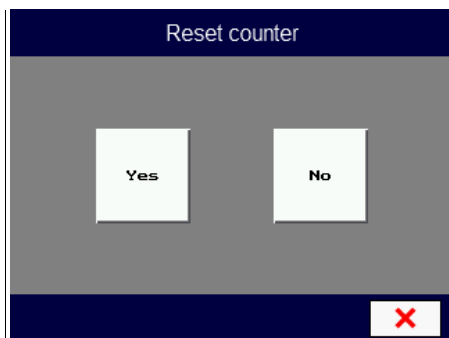

If also alarm limits have been set and this limit is exceeded the below screen will appear if you touch the “counter field” (< 2 sec.) during this alarm situation.

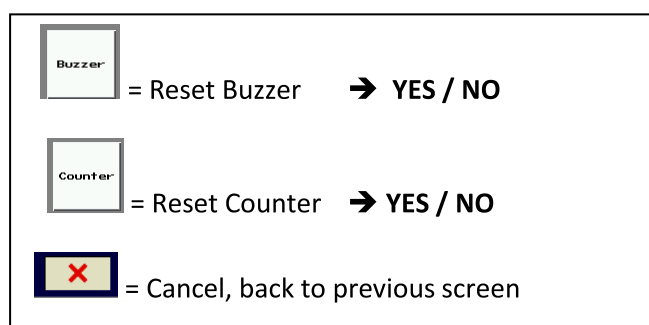
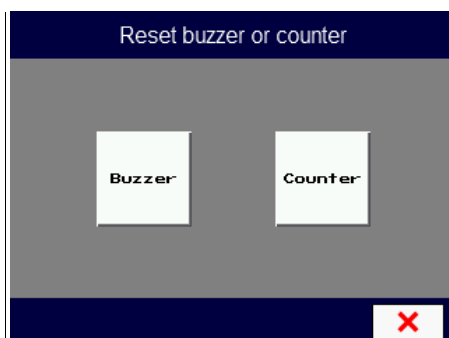

9. Menu Structure:

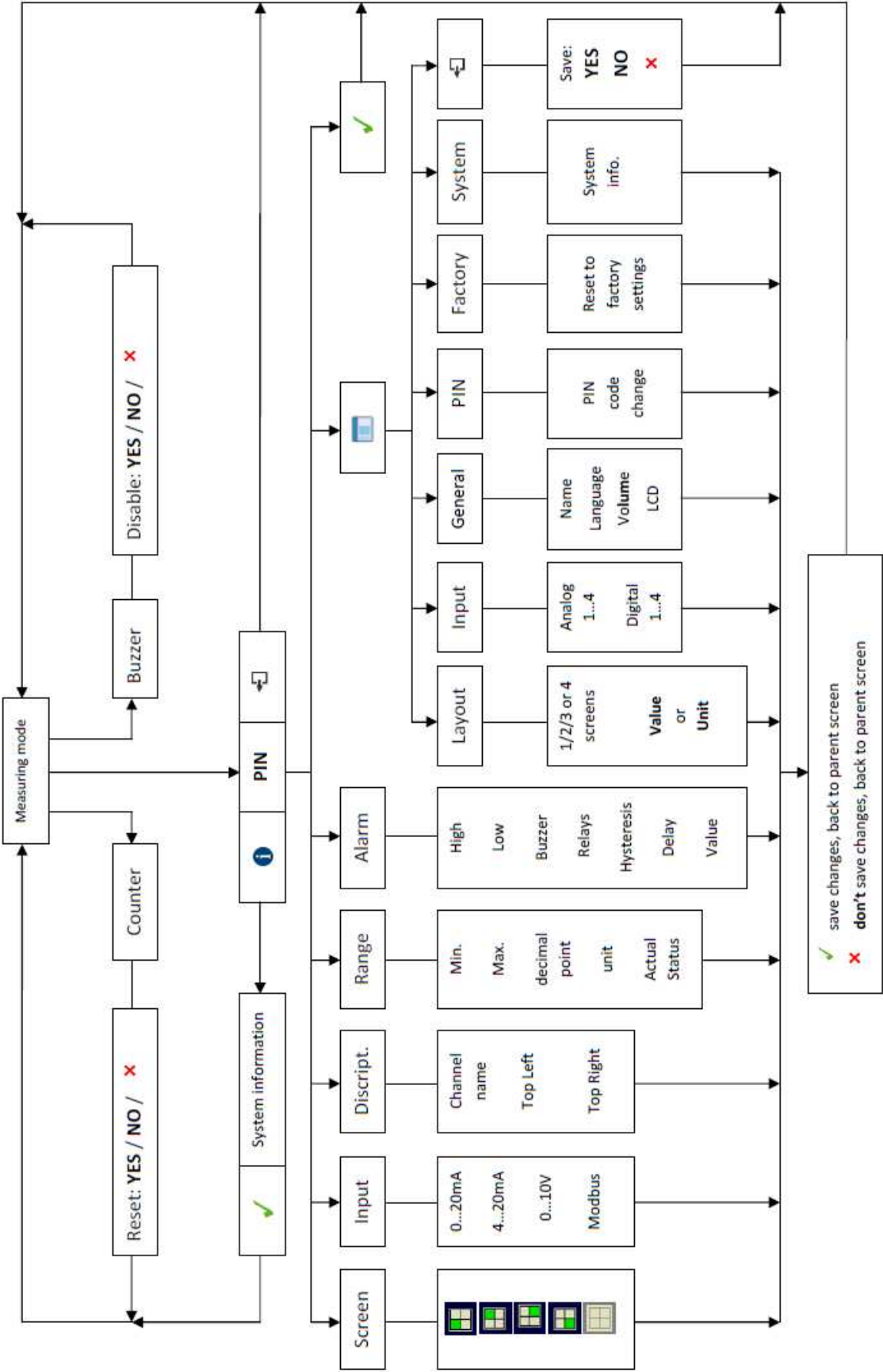

10. Configuration check

The unit automatically checks for errors after setup. This to exclude that no conflicting data is entered (for example: alarm limits are outside the measuring range etc.).

If conflicting data was entered you have already been warned by the "RED" background color of the input field and this warning has been ignored.

By returning to the measuring modus the below notification will appear for 30 seconds.



(down counter on the right)

By touching the screen >5 sec. and entering the correct PIN code the below screen will appear;

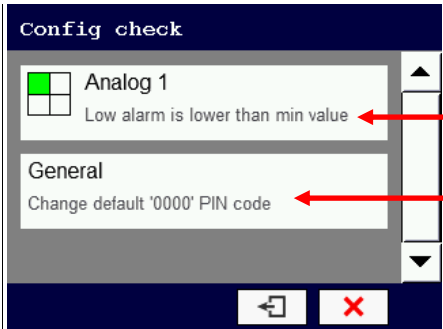

Here the **incorrect** setting will show.

By touching them you enter the setting menu so the error can be solved.