

PeakTech[®]

Prüf- und Messtechnik

 Spitzentechnologie, die überzeugt



PeakTech[®] 4130-1

PeakTech[®] 4135-1

PeakTech[®] 4140-1

Operation manual

Digital Spectrum Analyzer

Content	
1. Safety introduction	1
1.1. Safety terms and symbols	2
1.2. Safety Symbols on the product	2
1.3. Maintenance and cleaning	3
2. Einführung Digitale Spektrum Analysatoren	4
Chapter 1 Getting started	5
Chapter 2 Basic operation	11
3. Basic Settings	12
4. SPAN	15
5. Sweep and Function settings	21
6. Sweep	24
7. Trigger	27
8. Trace	28
9. Marker Measurement	30
10. Peak Search	35
11. Marker->	37
12. AUTO Tune	39
13. Display	39
14. Preset	40
15. System Setup	40
16. Source	41
17. Measure	41
Chapter 3 Remote control	43
18. Specifications	44
Chapter 4: Appendix	48

Overview

Chapter 1: Getting started

This chapter introduces the front and rear panels, user interface and notes for first operation of the Spectrum Analyzer.

Chapter 2: Front and Rear panel operation

This chapter describes the functions of the keys on the front panel, and introduces menu functions of each key in detail.

Chapter 3: Remote Control

This chapter introduces remote control methods of the Spectrum Analyzer.

Chapter 4: Appendix

This chapter provides the accessories list and service and support information of the Spectrum Analyzer.

1. Safety introduction

This product complies with the requirements of the following European Community Directives: 2004/108/EC (Electromagnetic Compatibility) and 2006/95/EC (Low Voltage) as amended by 2004/22/EC (CE-Marking).

To ensure safe operation of the equipment and eliminate the danger of serious injury due to short-circuits (arcing), the following safety precautions must be observed.

Damages resulting from failure to observe these safety precautions are exempt from any legal claims whatever.

Before operating this instrument, read the following safety precautions to avoid injury and prevent damage to this product or any products connected to it. For safe operation, be sure to operate this instrument in accordance with the provisions.

- Use proper power cord
Only power cord that is recognized by the country where this instrument is located is allowed.
- Reliable grounding
This product is grounded through the grounding wire of the power cord. To avoid electrical shock, before connecting any input or output terminal of the product, make sure reliable connection between the grounding terminal of the power cord of this product and protective earth terminal.
- Check all terminal ratings
Check all ratings and markings on the product to avoid the impact of fire and excessive current, please consult the manual for further ratings information before any connections.
- Overvoltage protection
Ensure that no excessive voltage (such as voltage caused by lightning or other large voltage) reach the product. Otherwise the operator may have a risk of electric shock.
- Do not operate without cover
Do not operate the Spectrum Analyzer with covers or panels removed.
- Use proper fuse
Only fuse specified by the Spectrum Analyzer is allowed.
- Do not expose circuit
Do not touch exposed connectors and components when the unit is powered.
- Do not operate with suspected failures
- If you suspect a failure of this product, please contact PEAKTECH authorized maintenance personnel to detect. Any maintenance, adjustment or parts replacement must be performed by PeakTech® authorized maintenance personnel.
- Keep proper ventilation
Try to ensure good ventilation, bad ventilation will cause temperature increase of the instrument, thereby causing damage to it. Keep good ventilation when operating, check the vents and fan regularly.

- **Operation environment**
To avoid internal short circuit or electric shock, do not operate the instrument in a damp environment.
Do not operate in an explosive atmosphere. To avoid equipment damage or personal injury, do not operate the instrument in an explosive atmosphere.
- **Clean and dry**
Keep product surface's clean and dry to avoid dust or air moisture affecting the performance of the instrument.
- **Electrostatic protection**
It may cause damage to the instrument if interface is with static electricity, so operate at anti-static area as much as possible to avoid static electricity when handling and operating.
Ground the inner and outer conductors of interface briefly to discharge static electricity before connecting cable to the instrument.
- **Handling**
To avoid instrument slipping down during handling which may damage the keys, knob or interfaces and other parts on the panel, please pay attention to handling safety

1.1. Safety terms and symbols

Terms in this guide. The following terms may appear in the guide:

Caution

Caution statement indicate the conditions and behaviors that may cause product damage or loss of data.

Warning!

Warning statement indicate the conditions and behaviors that may endanger the lives and safety of the operating personnel.

1.2. Safety Symbols on the product

The following terminologies may appear on this product:

- **Danger!**
Indicates an immediate injury once you carry out this operation.
- **Warning!**
Indicates a probable damage to this product or other devices that is connected with it once you carry out this operation.
- **Caution!**
Indicates a potential hazard once you carry out this operation.

The following symbols may appear on the product:



1.3. Maintenance and cleaning

Maintenance:

Do not place the instrument in the sunlight for a long time.

Clean:

Clean the instrument regularly according to using status.

Method is as follows:

1. To avoid electric shock, disconnect power before cleaning work.
2. Wipe the loose dust on the outside of the instrument with soft moist but not dripping cloth (use mild detergent or water, but not dissolved thinner, otherwise it will damage the designation strip or plastic parts). Be careful not to scratch the LCD protector when cleaning instruments with LCD screen.



Caution: Do not let any corrosive liquid stain the instrument to avoid damage.



Warning: Before re-energizing, make sure the instrument is completely dry to avoid short circuit even personal injury caused by moisture.

2. Brief introduction of Digital Spectrum Analyzer

The PeakTech® 4130-1 / 4135-1 / 4140-1 is a Spectrum Analyzer with compact design, easy handling, high cost – performance ratio and various functions. It has a keyboard layout which is easy to operate, high-definition color LCD screen and various remote communication interfaces. It can be widely used in many fields including education science, enterprise R & D and industrial production etc.

Main Features:

- Frequency range: 9 kHz to 3.0 GHz (P4140-1)
2.2 GHz (P4135-1)
1.5 GHz (P4130-1)
- Display Average Noise Level (DANL)-135 dBm (Typical value)
- Phase noise: -80 dBc/Hz (offset 10 kHz)
- Full-amplitude precision: ± 1.0 dB
- Resolution Bandwidth (RBW): 10 Hz
- Various measurement function and auto-setting function
- Multi-window display, accurate measurement
- Equipped with preamplifier and AM / FM demodulation function
- High stability oscillator
- 7 inch high-definition screen (800×480 pixels), the image interface is simple and clear which makes operation easy
- Equipped with various interfaces, such as LAN, USB Host, USB Device, RS232
- Compact design, weights only 6.0kg

Format specification:

1. Keys:

This guide usually uses “text box+text (bold)” to indicate a key on front panel, such as **FREQ** indicates **FREQ** key.

2. Menu:

This guide usually uses “character shading+text (bold)” to indicate a menu, such as “center frequency” indicates the center frequency menu option under **FREQ** key.

3. Connectors:

This guide usually uses "brackets + text (bold)," to indicate a connector on the front or rear panel. For example: [GEN OUTPUT 50Ω].

4. Operating steps:

This guide usually uses an arrow “→” to indicate the next step. For example: **FREQ** →center frequency→ indicates pressing **FREQ** function key on the front panel then pressing “→center frequency” → menu softkey.

Chapter 1 Getting started

This chapter introduces the front and rear panels, user interface and notes for first operation of the Spectrum Analyser.

The contents of this chapter are as follows:

- Initial inspect
- Outlook and dimensions
- Front panel
- Rear panel
- Parameter setting

Initial inspect

1. Inspect the transport package

Check the transport package and verify its contents is complete, keep the package and fill material before testing the analyzer.

2. Inspect the unit

Please inspect the unit carefully, if its content is not complete, or the analyzer does not pass the performance test, please contact your dealer or the manufacturer.

3. Check the accessories

Check the accessories according to the packing list, if damaged or missing, please contact your PeakTech distributor.

Outlook and dimension:

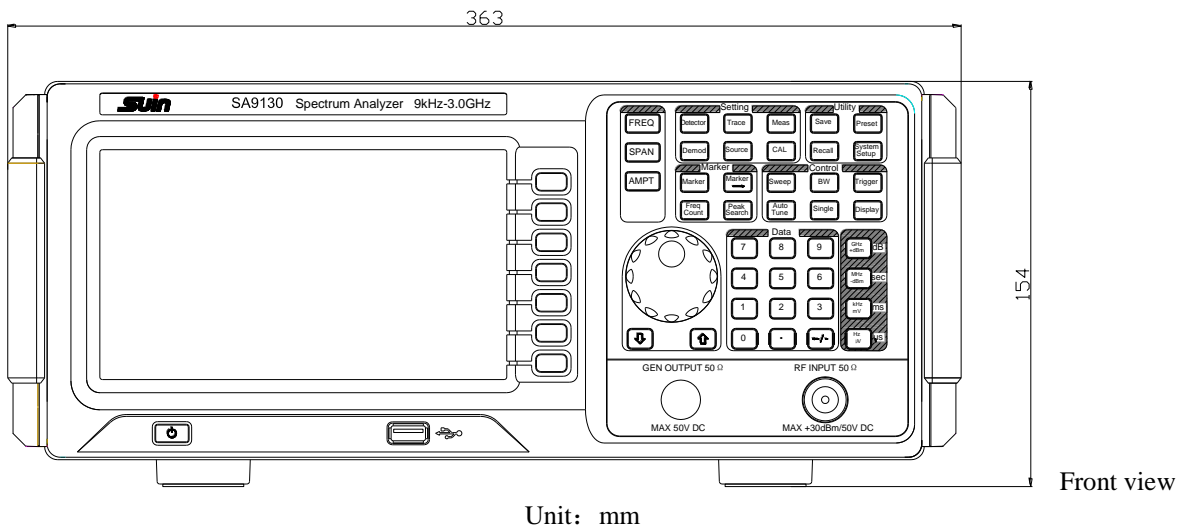

Prepare for use

Adjust the legs of the instrument

Open the legs of the Analyzer as bracket of the instrument to make it tilted upward before operation, which makes the following operation and observation more convenient. When the instrument is not in use, the user can close the support legs to facilitate placement or removal.

Switching the power on

Connect the Spectrum Analyzer to AC power with the power cord from the accessories, please refer to the introduction about the requirement of voltage and frequency of AC power in the “Rear panel” section.

Boot examination

Connect power cord properly, then press the power switch  on the front panel to turn on the Spectrum Analyzer. The boot screen displays the boot initialization process information, then displays sweep curve at the end.

Perform self-calibration

Please perform self-calibration after boot. Press **CAL** → Calibration → Immediate calibration to process self-calibration for the system with the internal calibration source of the system.

Front panel

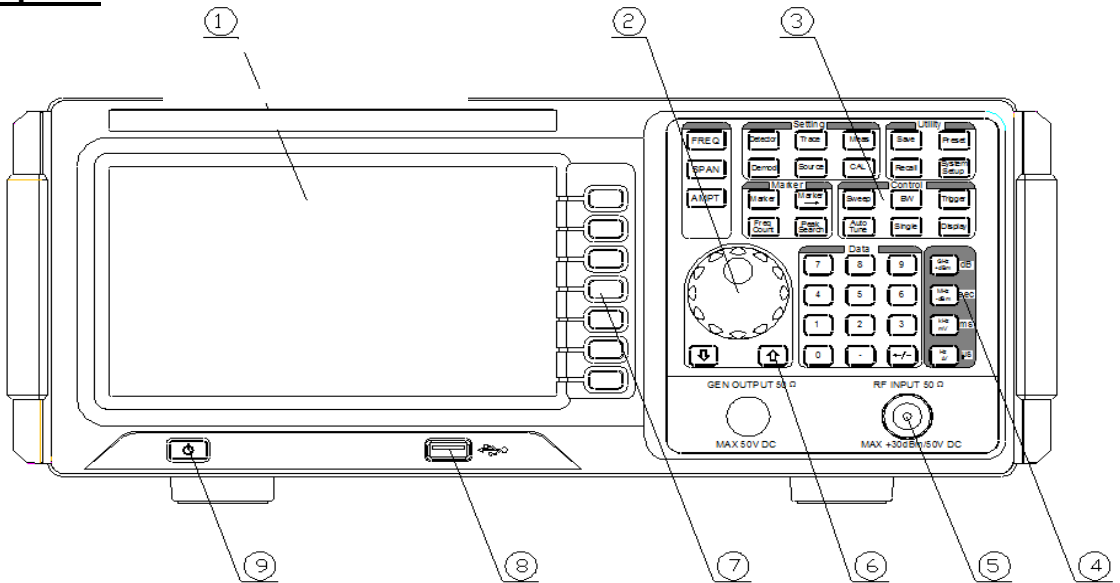

- ① LCD display screen ② Adjusting knob ③ Function key area ④ Digit keys
⑤ RF input ⑥ Direction keys ⑦ Menu software/ menu control key ⑧ USB Host ⑨ Power

Function keys on front panel:

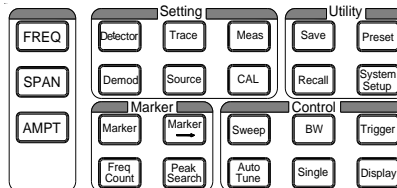

Table 1-2 Description of function keys on front panel

Function key	Function description
FREQ	Set informations like center frequency, start frequency and end frequency etc.
SPAN	Set the frequency range of sweep.
AMPT	Set parameters like reference level, RF attenuator, scale, Y-axis units etc. Set level offset, the largest mixer and input impedance. Used to perform automatic calibration, automatic range and turn on the preamplifier.
BW	Set resolution bandwidth (RBW) and video bandwidth (VBW) and V/R ratio.
Sweep	Set parameters like sweep time, mode etc.
Trigger	Set informations about trigger
Single	Set "single" trigger of the instrument
Display	Set informations about screen display
Auto Tune	Auto tune of full frequency range
Marker	Read amplitude, frequency or sweep time etc. of each point on trace through the marker
Marker—>	Set other system parameters of the instrument with current marker value
Freq Count	Set parameters like frequency count, resolution etc.
Peak Search	Unfold setting menu of peak search, and execute peak search function simultaneously
Demod	Config demodulation function **
Meas	Select and control measurement function **.
CAL	Set information about the auto calibration of the instrument .
Trace	Set parameters of trace.
Detector	Set detection mode of detector.
System Setup	Set parameters of system.
Triger	Set information about trigger.
Save	File save and read function.
Recall	Recall saved data and information.
Preset	Reset system to factory default state or user-defined state.

Note:

*The function is only applicable for the unit selected with according options.

Rear panel

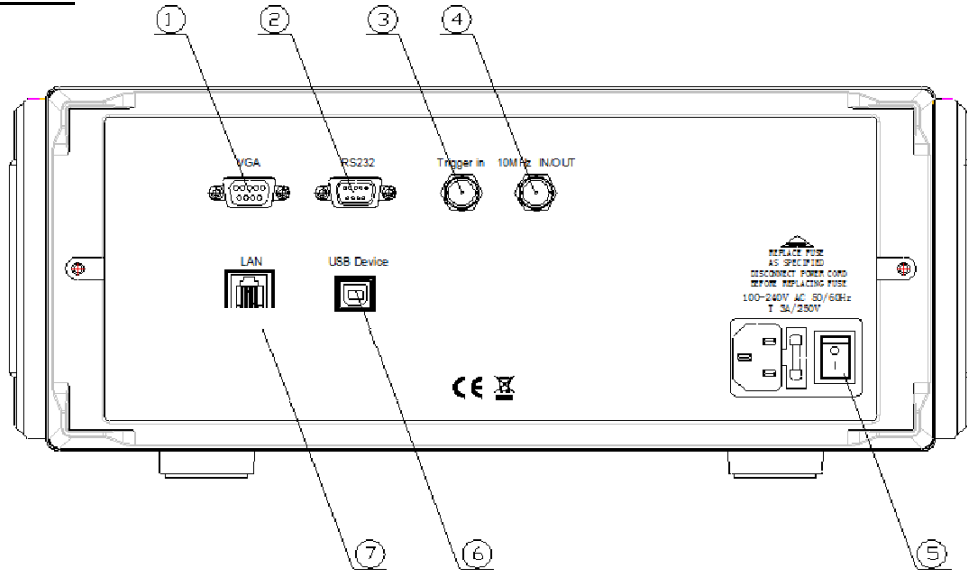

1. VGA port

This port provides VGA video signal output, connect this interface with VGA cable

2. RS-232 port

This port provides serial data output, connect this interface with RS-232 cable

3. TRIGGER IN

When the Spectrum Analyzer is under external trigger mode, this connector receives an external trigger signal. The external trigger signal is input to the Spectrum Analyzer through BNC cable

4. 10MHz IN/OUT

Realize reference clock input/ output through BNC cable

5. AC Power Connector

The AC power specifications that this instrument supports is: 100 V - 240 V, 45 Hz - 440 Hz

6. USB Device

The Spectrum Analyzer could connect with external USB device as "slave device"

7. LAN

This interface is used to connect the spectrum analyzer to the LAN to realize remote control.

Parameter setting

Realize parameter input with numeric keys, adjusting knob or direction keys. This section introduces three parameter setting methods with an example (set center frequency to 1500 MHz).

1. Use numeric keys

- 1) Press **FREQ** → Center frequency;
- 2) Use numeric keys to input value “750”;
- 3) Select desired unit “MHz” from the unit menu that pops up.

2. Use adjusting knob

In the parameters editable state, turn the knob to increase (clockwise) or decrease (counterclockwise) parameters at specified steps.

- 1) Press **FREQ** → Center frequency;
- 2) Turn the knob to get desired parameter value (750 MHz).

3. Use direction keys

In the parameter editable state, the direction keys can be used for the progressive increment or decrement of the parameter value according to a certain step.

- 1) Press **FREQ** → Center frequency;
- 2) Press the up / down direction key to get desired parameter value (750 MHz).

Chapter 2: Basic operation

The contents of this chapter are as follows:

- Basic Settings
- Sweep and Functions Settings
- Measurement Settings
- The using and function settings of Marker
- Shortcut
- System Settings

Basic Settings

3.1. FREQ

Set the frequency parameter of analyzer. The analyzer sweeps within a specified range, and the sweep will start once you change this parameter.

The frequency range of current channel can be expressed by either of two groups of parameters: Start Frequency/Stop Frequency (f_{start}/f_{stop}), or center Frequency/Span (f_{center}/f_{span}). If any one of them is adjusted, other three parameters will be changed accordingly to ensure their coupling relationship.

$$f_{center} = (f_{start} + f_{stop}) / 2$$

$$f_{span} = f_{stop} - f_{start}$$

3.2. Center Frequency

Enable the center frequency function, to allow a frequency displays in center be selected. When pressed, the frequency mode is switched to Center Frequency/Span for input. In this mode, parameters you specified are always shown at the lower right and left side of the display grid.

Key points:

- The start and stop frequencies vary with the center frequency when span is constant.
- Changing the center frequency horizontally shifts the current sweep channel and the adjustment is limited by the specified range in datasheet.
- In the Zero Span mode, start frequency, stop frequency and center frequency are always equal.
- User can modify this parameter by numeric keys, knob and arrow keys.

Table 2-1 Center Frequency

Parameter	Description
Default	0.75GHz (P4130-1) 1.1GHz (P4135-1) 1.5GHz (P4140-1)
Range	0Hz ~ 1.5GHz (P4130-1) 0Hz ~ 2.2GHz (P4135-1) 0Hz ~ 3.0GHz (P4140-1)
Unit	GHz, MHz, kHz, Hz
Knob Step	Span>0, step=span/200 Span=0, step=RBW/100, Min=1 Hz
Arrow Keys Step	CF step

3.3. Start Freq

Set the start frequency of current channel, displays at the left scale. When pressed, the frequency mode is switched to Start Frequency/Stop Frequency for input. In this mode, parameters you specified are always shown at the lower left and right side of the grid.

Key points:

- The span and center frequency are changed automatically according to the start frequency. The change of the span would have influence on other system parameters. For more details, please refer to “Span”.
- In Zero Span mode, the start frequency, stop frequency and center frequency are always equal.
- You can modify this parameter using the numeric keys, knob, or arrow keys.

Table 2-2 Start Frequency

Parameter	Description
Default	0 GHz
Range	0 Hz ~ 1.5GHz (P4130-1) 0 Hz ~ 2.2GHz (P4135-1) 0 Hz ~ 3.0GHz (P4140-1)
Unit	GHz, MHz, kHz, Hz
Knob Step	Span>0, step=span/200 Span=0, step=RBW/100, Min=1 Hz
Arrow Keys Step	CF step

3.4. Stop Freq

Set the stop frequency of current channel, displays at the right scale. When pressed, the frequency mode is switched to Start Frequency/Stop Frequency for input. In this mode, parameters you specified are always shown at the lower left and right side of the grid.

Key points:

- The span and center frequency are changed automatically according to the stop frequency. The change of the span would have influence on other system parameters. For more details, please refer to “Span”.
- You can modify this parameter using the numeric keys, knob, or direction keys.

Table 2-3 Stop Frequency

Parameter	Description
Default	1.5 GHz (P4130-1) 2.2 GHz (P4135-1) 3.0 GHz (P4140-1)
Range*	0Hz ~ 1.5GHz (P4130-1) 0Hz ~ 2.2GHz (P4135-1) 0Hz ~ 3.0GHz (P4140-1)
Unit	GHz, MHz, kHz, Hz
Knob Step	Span>0, step=span/200 Span=0, step=RBW/100, Min=1 Hz
Arrow Keys Step	CF step

*Note: The range is from 100 Hz to 3.0GHz in non-zero span.

3.5. CF Step

Set the CF step. User can modify the center frequency by fixed step continuously switches the channel to be measured.

Key points:

- Setting for CF step could be “Manual” or “Auto”. In “Auto” mode, CF step is 1/10 of span for non-zero span, and equals the RBW for zero span. In “Manual” mode, user can input data by numeric keys.
- After setting of appropriate CF step and center frequency, user can switch the measured channel with specified step by Up/Down keys in order to sweep the adjacent channels manually.
- You can modify this parameters by numeric keys, knob, or arrow keys.

Table 2-4 CF Step

Parameter	Description
Default	150MHz (P4130-1) 220MHz (P4135-1) 300MHz (P4140-1)
Range	1 Hz ~ 1.5GHz (P4130-1) 1 Hz ~ 2.2GHz (P4135-1) 1 Hz ~ 3.0GHz (P4140-1)
Unit	GHz, MHz, kHz, Hz
Knob Step	Span>0, step=span/200 Span=0, step=VBW/100, Min=1 Hz
Arrow Keys Step	In 1-2-5 sequency

3.6. Signal Track

Enable or disable the function of signal track. Tracks signals with unstable frequency and less than 3dB transient variation in amplitude by placing Marker 1(refer to “Marker Measurement”) onto the measured signal to track the variation continuously.

Progress of signal track as figure 2-1:

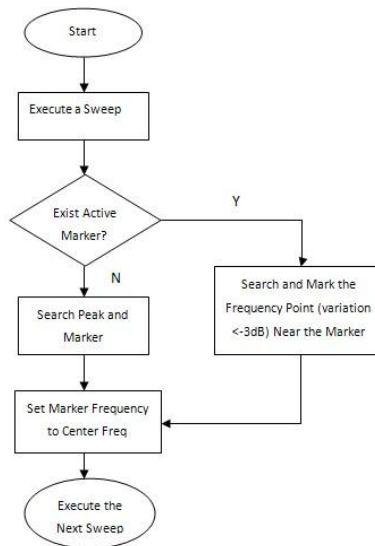

Figure 2-1

Key points:

- When Signal Track is on, the ST icon is shown at the left of screen.
- If an active marker exists, when Signal Track is on, the analyzer will search and mark the point (with no more than 3dB variation in amplitude) near the marker, set the frequency of this point as center frequency and hold the signal at the center of screen.
- If no marker is active, when Signal Track is on, Marker 1 is enabled and executes a peak searching, set the current peak frequency as center frequency and hold the signal at the center of the screen.
- In continuous sweep, the system tracks continuously. In single sweep, only track one signal. In zero span, Signal Track is invalid.

4. SPAN

Set the span of analyzer. The frequency parameter varies with the span. Once change the span, sweep will be restarted.

4.1. Span

Set the frequency range of current channel. When pressed, the frequency mode is switched to Center Freq/Span for input, and the Center Freq and Span are shown at the lower left and right of the display grid.

Key points:

The Start/Stop Frequency varies with the changing of Span automatically.

- In manual span mode, the minimum can be set as 100Hz (the only way to zero span is to press the **Zero Span** menu option), the maximum is described in “**Specification**”, analyzer enter into full span mode when select maximum setting.
- In non-zero span mode, CF step and RBW changes with the span when they are Auto mode, and changing of RBW will influence VBW (in Auto mode).
- Any changes among Span, RBW and VBW will influence Sweep Time.
- In non-zero span mode, some functions are invalid, like “Video” trigger, “1/Δtime” readout.
- You can modify this parameter by numeric keys, knob and arrow keys.

Table 2-5 Span

Parameter	Description
Default	1.5 GHz (P4130-1) 2.2 GHz (P4135-1) 3.0 GHz (P4140-1)
Range*	0Hz ~ 1.5GHz (P4130-1) 0Hz ~ 2.2GHz (P4135-1) 0Hz ~ 3.0GHz (P4140-1)
Unit	GHz, MHz, kHz, Hz
Knob Step	span/200, Min=1 Hz
Arrow Keys Step	In 1-2-5 sequence

* Note: 0 Hz is only available in zero span.

4.2. Full Span

Set the span of analyzer to be maximum.

4.3. Zero Span

Set the span of analyzer to be 0Hz. In this case, stop frequency and start frequency are both equal to center frequency, the horizontal axis denotes time. The analyzer here is measuring the time domain characteristics of amplitude where frequency point is.

Key points:

- In zero span mode, the analyzer displays the time domain characteristic of fixed frequency component, which has many difference with non-zero mode, and the following functions are valid in zero span mode:
- **FREQ** : Signal Track
- **Marker->** : “Mkr->CF”, “Mkr->Step”, “Mkr ->Start”, “Mkr ->Stop”, “Mkr Δ ->CF” and “Mkr Δ ->Span”.
- **Marker** : Readout of “Frequency”, “Period” and “1/ Δ time” (valid in Delta marker type).

4.4. Last Span

Set the span of analyzer to be previous setting.

4.5. AMPT

Enable the reference level and enter into the amplitude menu. Through these parameters, tested signal can be displayed at an optimal view with least error.

4.6. Auto Scale

To set the highest resolution for Y axis of current screen on condition that the signal is full displayed. A reference level is set automatically and ensures the peak of signal always on the topmost of grid for best view of tracing line.

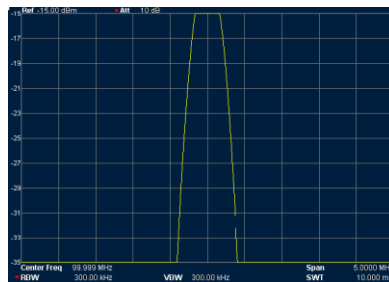

Figure 2-2 Before Auto Scale

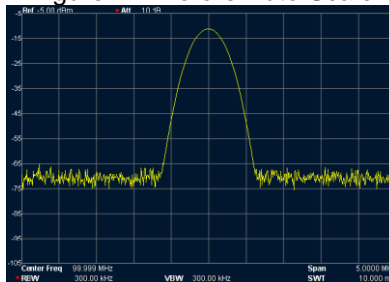

Figure 2-3 After Auto Scale

4.7. Ref Level

Set the reference level, indicates at the top scale as amplitude power or voltage. When change the reference level, the topmost scale of absolute amplitude level changes accordingly shown at the upper left of the display grid.

Key points:

- Maximum reference level is affected by combination of maximum mixing level, input attenuation and preamplifier. When adjust it, the input attenuation is adjusted under a constant max mixing level, meeting:

$$L_{Ref} - a_{RF} + a_{PA} \leq L_{mix}$$

L_{Ref} , a_{RF} , a_{PA} and L_{mix} denote reference level, input attenuation, preamplifier and maximum mixing level.

- You can modify this parameter by numeric keys, knob and arrow keys. For more details, please refer to "Parameter Input".

Table 2-6 Reference Level

Parameter	Description
Default	0dBm
Range	-100 dBm ~ 30 dBm
Unit	dBm, -dBm, mV, uV
Knob Step	in Log scale mode, step=scale/10 in Lin scale mode, step=0.1 dBm
Arrow Keys Step	in Log scale mode, step=scale in Lin scale mode, step=1 dBm

4.8. Input Atten

Set the front attenuation of the RF input in order to permit big signals (or small signals) to pass from the mixer with low distortion (or low noise).

Key points:

- When preamplify is on, up limit for input attenuation can set to be 30dB. You can adjust reference level to ensure above formula 2-3.
- You can modify this parameter by numeric keys, knob and arrow keys. For more details, please refer to "Parameter Input".

Table 2-7 Input Attenuation

Parameter	Description
Default	10dB
Range	0 dB ~ 50 dB
Unit	dB
Knob Step	5 dB
Arrow Keys Step	5 dB

4.9. Scale/Div

Only in Log scale mode, set the logarithmic units and scale value per vertical grid division on the display.

Key points:

- Trough changing the scale, the displayed amplitude range is adjusted.
- Amplitude range can be displayed:
Min: Reference level – 10 × scale ;
Max: Reference level
- You can modify this parameter by numeric keys, knob and arrow keys. For more details, please refer to “**Parameter Input**”.

Table 2-8 Scale

Parameter	Description
Default	10dB
Range	0.1 dB ~ 20 dB
Unit	dB
Knob Step	Scale \geq 1, step=1 dB Scale $<$ 1, step=0.1 dB
Arrow Keys Step	In 1-2-5 sequence

4.10. Scale Type

Set the scale type of Y-axis to Lin or Log, the default is Log.

Key points:

- In Log scale type, Y-axis denotes the logarithmic coordinate, top grid shows reference level, and the grid size is equal to the scale value. The unit of Y-axis will be switched to be dBm as default when the scale type is changed from Lin to Log.
- In Lin scale type, Y-axis denotes linear coordinate, top grid shows reference level and bottom grid is 0V, the grid size is 10% of the reference level and scale setting is invalid. The unit of Y-axis will be switched to be Volts as default when the scale type is changed from Log to Lin.
- Scale type will not affect the unit of Y-axis.

4.11. Y-axis Units

Set the unit of Y-axis to dBm, dBmV, dBuV, Volts or Watts.

dBm, dBmV, dBuV are unit for Log scaling, but Volts and Watts are unit for Lin scaling. Default unit is dBm.

4.12. Ref Offset

Assign an offset to the reference level to compensate for gains or losses generated between the measured device and the analyzer. Then the level of external amplitude transformer input can be taken as reference for measured signal level.

Key points:

- The change of this parameter will not change the position of curve on screen, but change the read out of the reference level and marker amplitude.
- You can modify this parameter by numeric keys. For more details, please refer to “**Parameter Input**”.

Table 2-9 Reference level offset

Parameter	Description
Default	0dB
Range	-300 dB ~ 300 dB
Unit	dB
Knob Step	No
Arrow Keys Step	No

4.13. Auto Range

Auto change the amplitude parameters within current span for easy view of the signal display in main screen.

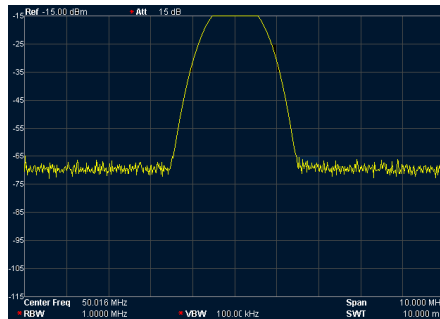

Figure 2-4 Before Auto range

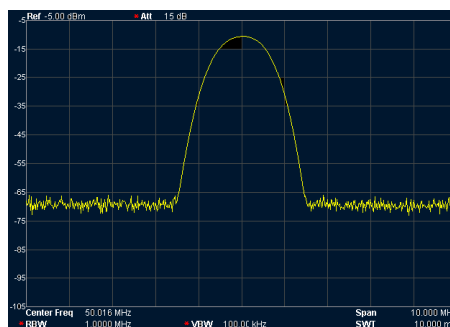

Figure 2-5 After Auto range

Key points:

- The difference between **Auto Range** and **Auto Scale** is that **Auto Range** can solve the overrange problem caused by parameter setting and adjust the max. mix level to accords with signal.
- The difference between **Auto Range** and **Auto** is that: **Auto Range** adjusts the main channel signal but not change the frequency settings. **Auto** searches signal in full span and locate the signal at the center frequency.

4.14. Int Preamp

Turn on or off the preamplifier located at front of RF. When the function enabled, the preamplifier will reduce the display average noise level in order to distinguish the small signal among noises.

Key points:

- The icon will be displayed on the left screen when the preamplifier is on.

4.15. Max Mix Level

Set max input level of mixer according to the manaitude of signal.

Key points:

- For bigger input signal, select small max mixing level in order to increase input attenuation and reduce distortion. For smaller input signal, select big max mixing level in order to reduce input attenuation and distortion.
- Paramter in formula 2-3, are always changing on the basis of max mixing level.
- You can modify this parameter by numeric keys, knob and arrow keys. For more details, please refer to “**Parameter Input**”.

Table 2-11 Max mix level

Parameter	Description
Default	-10dBm
Range	-50 dBm ~ 0 dBm
Unit	dBm, -dBm, mV, uV
Knob Step	1 dBm
Arrow Keys Step	10 dBm

5. Sweep and Function Settings

Set the parameters of RBW (Resolution Bandwidth), VBW (Video Bandwidth) and Dectector.

5.1. RBW

Set the RBW (Resolution Bandwidth) in order to distinguish two close signals.

Key points:

- Reducing the RBW to get higher frequency resolution, but will cause the longer sweep (In Auto Sweep mode, sweep time will be affected both by RBW and VBW).
- In Auto RBW mode, RBW decreases with the span (non-zero span).
- You can modify this parameter by numeric keys, knob and arrow keys. For more details, please refer to “**Parameter Input**”.

Table 2-12 RBW (gaussian filter selected)

Parameter	Description
Default	1 MHz
Range	10 Hz ~ 1 MHz
Unit	GHz, MHz, kHz, Hz
Knob Step	In 1-3-10 sequence
Arrow Keys Step	In 1-3-10 sequence

5.2. VBW

Set the VBW (Video Bandwidth) in order to remove the band noise.

Key points:

- Reducing the VBW to smooth spectrum line and differentiate small signal from the noise, but also will cause the longer sweep (In Auto Sweep mode, sweep time will be affected both by RBW and VBW).
- In Auto mode, VBW will change with RBW, but not affected by RBW in Manual mode.
- You can modify this parameter by numeric keys, knob and arrow keys. For more details, please refer to “**Parameter Input**”.

Table 2-13 VBW

Parameter	Description
Default	1 MHz
Range	1 Hz ~ 1 MHz
Unit	GHz, MHz, kHz, Hz
Knob Step	In 1-3-10 sequence
Arrow Keys Step	In 1-3-10 sequence

5.3. V/R Ratio

Set the ratio of VBW to RBW. If the response of signal is very close to noise level, to avoid the signal to be covered by noise, you need to set the ratio less than 1 to reduce noise.

Key points:

- Select right V/R Ratio while measuring different kinds of signal:
Sine signal: Select 1 to 3 (for faster sweeps).
Pulse Signal: Select 10 (reduce the influence on amplitude of transient signals)
- You can modify this parameter by numeric keys, knob and arrow keys. For more details, please refer to “**Parameter Input**”.

Table 2-14 V/R Ratio

Parameter	Description
Default	1
Range	0.000001 ~ 100000
Unit	No
Knob Step	In 1-3-10 sequence
Arrow Keys Step	In 1-3-10 sequence

5.4. Detector

Set the detector type of analyzer for different signal measurement.

5.4.1. Detector Type

While displaying a wider span, analyzer always capture the whole data for each pixel within a specified time. Then, the data will be processed (Peak Value, Average Value) by current selected detector and shown on screen after finishing the processing.

Key points:

- Select appropriate detector type according to the application to ensure the accuracy of the measurement.
- Optional detector types are: Pos Peak, Neg Peak, Sample, Normal, RMS Avg and Voltage Avg, the default is Pos Peak.
- Each selected type is shown with a parameter icon on the left status bar of screen as Figure 2-6 below:



Figure 2-6

1. Pos Peak

Search the maximum from the sampling data segment and display it. In this type, the signal will not be missed even with very small resolution, which is very helpful for EMC test.

2. Neg Peak

Search the minimum from the sampling data segment and display it at the corresponding pixel.

3. Sample

Sample type shows the transient level of the center time in corresponding interval for each pixel of curve. If the span is far bigger than RBW, the detector will not be such reliable. So sample type is only applicable for Noise signal or similar ones.

4. Normal

Normal also can be named as Pos Normal or Rosenfell, that is searching both the minimum and maximum from the sampling data segment and displays maximum at each odd pixel, minimum at each even pixel. In this type, user can intuitively view the change range of amplitude.

5. RMS Avg

Calculate the data from the sampling data segment with mean square root operation and display the result. This type can reject noise and easy for user to view the weak signal.

$$V_{RMS} = \sqrt{\frac{1}{N} \times \sum_{i=1}^N v_i^2}$$

Where, V_{RMS} denotes the mean square root value of voltage, unit is V. N denotes the number of samples assigned for each pixel. v_i denotes the envelop of the samples, unit is V.

Reference Resistance R can be used for Power calculation:

$$P = \frac{v_{RMS}^2}{R}$$

6. Voltage Avg

Average the data from sampling assigned to pixel and displays the result.

$$V_{AV} = \frac{1}{N} \times \sum_{i=1}^N v_i$$

Where, V denotes the average of voltage with unit V , N denotes the number of samples assigned to each pixel. v denotes the envelope of samples with unit V .

6. Sweep

Set the parameters about sweep and trigger, such as Time, Mode, SWT Count and Trig Type.

6.1. Time

Set the time for the analyzer to complete a sweep within span. Either Auto or Manual can be used, the default is Auto.

Key points:

- In non-zero span mode, once you select Auto, the analyzer will choose the shortest sweep time according to current parameter setting, such as RBW, VBW and so on.
- Decreasing sweep time will speed the measurement. But if your specified time is less than the shortest sweep time in Auto coupling, it will lead to error in measurement, and "UNCAL" will be shown at the status bar of the screen.
- You can modify this parameter by numeric keys, knob and arrow keys.

Table 2-15 Sweep time

Parameter	Description
Default	50 ms
Range*	20 us ~ 1500s (P4130-1) 20 us ~ 2200s (P4135-1) 20 us ~ 3000 s (P4140-1)
Unit	Ks, s, ms, us
Knob Step	Sweep time/100, Min = 1ms
Arrow Keys Step	In 1-1.5-2-3-5-7.5 sequence

* Note: in non-zero mode, minimum is 10 ms.

6.2. Mode

Set the sweep mode to Single or Continue, the default is Continue. The icon for selected mode will be shown at the left status bar of screen.



1. Single

Set the sweep mode to Single and the number 10 in parameter icon shows the current sweep number.

2. Continue

Set the sweep mode to Continue. The “Cont” in parameter icon denotes the analyzer is sweeping continuously.

Key points:

- In single mode, when pressed, the system enter into continue sweep mode and will sweep when trigger condition allows.
- In continue mode, the system send initialization signal automatically and enter into the judgement program directly when each sweep finishes.

6.3. Single

In single sweep mode, the menu is used for the initialization of trigger. After executing, the system will sweep (or measure) as specified numbers when trigger condition allows.

Key points:

- In continue mode, when select Single menu, the system enter into single sweep mode and will sweep with specified numbers when trigger condition allows.
- If the sytem has been already in single mode, selecting this menu will make anlalyzer sweep (or measure) as specified number when trigger condition allows.
- In single sweep mode, the system needs to execute the trigger initialization first and then judge the trigger condition.

6.4. Points

Set the desired points for each sweep. That is the points of current trace.

Key points:

- When sweep time is limited by sampling rate of ADC (Analog to Digital Converter), modifying the sweep numbers will affect sweep time. That is, the more points, the longer sweep time will be.
- Modifying the numbers also influences other system parameters, so system will restart sweep and measure.
- You can modify this parameter by numeric keys, knob and arrow keys. For more details, please refer to "Parameter Input".

Table 2-16 Sweep points

Parameter	Description
Default	601
Range	101 ~ 3001
Unit	No
Knob Step	1
Arrow Keys Step	100
Hint	
<ul style="list-style-type: none">• Along with the increasing of the sweep points (more than 601), the resolution of marker point will be increased too, but the sweep speed will be decreased.• Except of Sweep Points, other parameters also influence the speed of sweep, Like Span, RBW, VBW, Detector Type and Center Frequency.	

6.5. SWT Count

Set the number of time for a single sweep. The system will execute specified numbers of sweep and the number in icon shown at the left status bar of screen changes along with the process of sweep.

Table 2-17 Sweep Count

Parameter	Description
Default	1
Range	1 ~ 9999
Unit	No
Knob Step	1
Arrow Keys Step	1

7. Trigger

Set the parameters of trigger function.

7.1. Trig Type

The trigger type includes Free Run, Video and External. Each icon of selected type will be shown at the left of screen.

1. Free Run

Whenever the trigger condition is satisfied, the analyzer will generate trigger signal continuously.

2. Video

When detected voltage of a video signal exceed the video trigger level you specified, the analyzer will generate the trigger signal. This mode is invalid for non-zero span, RMS Avg of zero span and Voltage Avg of detector.

3. External

Input an external signal (TTL signal) through [**TRIGGER IN**] connector on rear panel. When the trigger condition is satisfied, the analyzer will generate trigger signals.

7.2. Trig Setup

1. Trig Level

When you select trigger level in Video Mode, the trigger level line and value will be shown in the screen.

You can modify this parameter by numeric keys, knob and arrow keys. For more details, please refer to "**Parameter Input**".

Table 2-18 Trigger level

Parameter	Description
Default	0 dBm
Range	-300 dBm ~ 50 dBm
Unit*	dBm
Knob Step	1 dBm
Arrow Keys Step	10 dBm

*Note: This is in connection with unit of current selected Y-axis.

2. Trig Edge

Set the trigger edge in External mode to Pos or Neg of Pulse.

8. Trace

Sweep signal is shown as trace on screen.

8.1. Select Trace

Analyzer can show 3 traces at most with different trace color (Trace 1-yellow, Trace 2- light blue, Trace 3-red). Trace 1, 2, 3 can be set by users and trace 4 is formed by math operation on base of other 3 traces. Select trace and set related parameters of them. The default is Trace 1 and trace type is Clear Write.

Note:

The current trace shown on the screen could be saved in analyzer or external memory and recall when needed. User can press "Save" key to store the data, detail method is described in "Save".

8.2. Trace Type

Set the type of the current trace or disable it. The system calculates the sample data with a specific operation according to the selected trace type and finally displays the result. Trace type includes Clear Write, Max Hold, Min Hold, Video Avg, Power Avg and Freeze. Each icon of selected type will be shown at the left of screen. Take Trace 1 for example as below:



Figure 2-7

1. Clear

Clear all the data saved for previous trace and continuously displays the signals that are the data of points during the sweep.

2. Max Hold

Maintains the maximum for each point of the trace, and updates each trace point if a new maximum is generated in successive sweeps.

3. Min Hold

Maintains the minimum for each point of the trace, and updates each trace point if a new minimum is generated in successive sweeps.

4. Video Avg

Display the trace after a logarithmic mean is calculated for each point of the trace in successive sweeps. Traces in this type are smoother.

5. Power Avg

Display the trace after an average for each point of the trace in successive sweeps. Traces in this type are smoother.

6. View

Hold and display the amplitude data of selected trace. Register stop updating trace data in order to view and read the data. This type is generally used by traces from the storage devices or remote interface download to system, the default type is View.

7. Blank

Disable the trace display and all measurement based on trace.

8.3. Average Times

Set the average times of trace.

Key points:

More averaging will reduce the noise and influence of other random signals, also better display the stable signal characteristics. The more averaging takes, the smoother the trace will be.

You can modify this parameter by numeric keys. For more details, please refer to “**Parameter Input**”.

Table 2-19 Average Times

Parameter	Description
Default	100
Range	1 ~ 1000
Unit	No
Knob Step	No
Arrow Keys Step	No

8.4. Math

1. Function

Set the computational method of the math trace.

- A-B: subtract Trace B from Trace A.
- A+Constant: add a constant to Trace A.
- A-Constant: subtract a constant from Trace A.

2. A

Assign a value to A from Trace 1, Trace2 or Trace 3. The default is Trace 1 (“T1”).

3. B

Assign a value to B from Trace 1, Trace2 or Trace 3. The default is Trace 1 (“T2”).

4. Constant

Set the value of constant for math trace.

You can modify this parameter by numeric keys. For more details, please refer to “**Parameter Input**”.

Table 2-20 Constant in math operation

Parameter	Description
Default	0 dB
Range	-300 dB ~ 300 dB
Unit	dB

5. Operate

Enable or disable the display of math trace, the default is off.

8.5. All Clear

Clear all trace on screen. Advanced measurement stop when as there is no available data source.

9. Marker Measurement

9.1. Marker

The marker shows as a rhombic sign for marking the trace point. Easy for user to readout the amplitude, frequency and sweep time of each point through marker.

Key points:

Screen can show 4 pairs of marker at most, but only one pair or one single marker is active every time.

In marker menu, you can input frequency and time by numeric keys, knob and arrow keys, also view the readout of point on trace.

9.2. Marker Select

Select one marker from four, the default is Marker 1. Then select other parameters such as marker type, marker trace and readout type for this marker. The enabled marker will appear on the selected trace through the Marker Trace option. And the readout of active marker located on marker place will be displayed in active function area and upper right of screen.

Table 2-21 Marker parameters

Parameter	Description
Default	Center frequency
Range	0 ~1.5GHz (P4130-1) 0 ~2.2GHz (P4135-1) 0 ~3.0GHz (P4140-1)
Unit	Readout=Frequency(or Period), unit is GHz, MHz, kHz, Hz (or ks, s, ms, us, ns, ps) Readout=Time (or 1/ Δ time), unit is ks, s, ms, us, ns, ps (or GHz, MHz, kHz, Hz)
Knob Step	Readout=Frequency(or Period), step=span/(sweep points-1) Readout=Time (or 1/ Δ time), step=sweep time/(sweep points-1)
Arrow Keys Step	Readout=Frequency(or Period), step=span/10 Readout=Time (or 1/ Δ time), step=sweep time/10

9.3. Normal

Normal is one of marker type, used to measure X (frequency or time) and Y (amplitude) of one point on trace. When selected, a marker with current number will appear on trace.

Key points:

- If there is no active marker, pressing this key will enable a marker at the palce of center frequency for current trace. If there is active marker, it will be enabled after pressing this key.
- You can shift the marker by numeric keys, knob and arrow keys and the readout of current marker will be shown at the upper right of screen.
- The resolution of X-axis (frequency or time) readouts corresponds to the span, you can lower span to get higher resolution for readout.

9.4. Delta

Delta is one of marker type, used to measure the difference between “reference marker” and “certain point on trace”: X value (frequency or time) and Y value (amplitude). When this type selected, a pair of markers will appear on trace, Reference Marker (indicated with number and letter “R”, like “1R”) and Delta Marker (indicated with number, like “1”).

Key points:

- If there is active marker, pressing this key will enable a reference marker at the place of current marker. Or else both the reference marker and Delta Marker will be activated together at the position of center frequency.
- The position of Reference Marker is always fixed (X and Y), but the Delta Marker can be shifted by numeric keys, knob and arrow keys if it is active.
- The differences of frequency (or time) and amplitude between two markers are shown at the upper right of screen.
- The methods of making one point as reference:
 - a) Open a Normal Marker and place it on one point. Then switch the marker type to Delta and this point becomes reference by changing the position.
 - b) Open a Delta Marker and place it on one point. Then select Delta menu again, so that Reference Marker is located on this point and be available to measure the delta by changing the position.
- Enable “Noise Marker” function under **Marker Fctn** menu, then the result of noise measurement will be more accurate by auto correction and be normalized to 1Hz.

The application of Delta Marker: to measure the signal-noise ratio of single spectrum signal. For example, place the Reference Marker at the position of signal and Delta Marker at the position of Noise, the measuring amplitude is the signal-noise ratio.

9.5. Delta Pair

Delta Pair is one of marker types. When selected, a pair of markers will appear on trace, which are Reference Marker (indicated with number and letter “R”, like “1R”) and Delta Marker (indicated with number and letter “D”, like “1D”).

Key points:

- You can adjust the position of reference marker (select “reference”) and Delta Marker by numeric keys, knob and arrow keys.
- The difference between **Delta Pair** and **Delta**: you just can modify the delta point in **Delta** type, but you can modify both delta point (select Delta option) and reference point (select “Reference” option) in Delta Pair type. Additionally, X and Y keeps unchanged during sweep in Delta type, but the Y-axis change along with sweep while X-axis keeps unchanged in **Delta Pair** type.

9.6. Span Pair

One of the marker types. When selected, a pair of markers will appear on trace, which are Reference Marker (indicated with number and letter "R", like "1R") and Delta Marker (indicated with number and letter "D", like "1D").

Key points:

- You can adjust the position of reference marker (select "reference") and Delta Marker by numeric keys, knob and arrow keys at the same time.
- When select "Range", adjusting "Span Pair" will keep the center position of two markers and just move them to sides (value increasing) or center (value decreasing).
- When select "Center", adjusting "Span Pair" will keep the relative distance and just move the center to left (value increasing) or right (value decreasing).
- The difference between **Span Pair** and **Delta**: you just can modify the delta point in **Delta** type, but you can modify both delta point (select Delta option) and reference point (select "Reference" option) in **Span Pair** type at the same time.

9.7. Off

Turn off the current selected marker. All the information and related functions will also be turned off.

9.8. Marker Trace

Select one trace for current marker from 1, 2, 3 Math and Auto (default). When select Auto, the system will search desired trace in the order of "Clear Write", "Max Hold", "Min Hold", "Video Avg", "Power Avg" and "Freeze". If search more than two traces as result, it will be selected in sequence of trace number 1, 2, 3 accordingly.

9.9. Readout

Set the readout type for X-axis. You can set different type for each marker, which just change the reading mode, not actual value. This setting will influence the marker readout shown in active area and upper right of screen.

1. Frequency

In this type, Normal marker shows the absolute frequency, and the other types (Delta, Delta Pair and Span Pair) show the frequency difference between the Delta Marker and Reference Marker. In non-zero span mode, default readout type is Frequency.

2. Period

In this type, Normal marker shows the reciprocal value of frequency, and the other types (Delta, Delta Pair and Span Pair) show the reciprocal value of frequency difference between the Delta Marker and Reference Marker. When the frequency difference is zero, the displayed value is infinite and shown as 10Ts. This readout type is invalid in Zero span mode.

3. ΔTime

In this type, Normal marker shows the time difference between the marker and sweep start, and the other types (Delta, Delta Pair and Span Pair) show the sweep time difference between the Delta Marker and Reference Marker. In Zero span mode, the default readout type is Time.

4. 1/Δtime

In this type, the analyzer shows the reciprocal value of time difference between the Delta Marker and Reference Marker. When the sweep time difference is zero, the displayed value is infinite and shown as 100THz. This readout type is only available when Delta Marker selected under Zero span mode, applicable for measuring of the frequency of video signal.

9.10. Marker Fctn

Set special measuring functions of marker such as Noise Marker, N dB BW and Frequency Count.

9.11. Select Marker

Select marker to be used for the specific measuring, the default is Marker 1.

9.12. Noise Marker

Execute the Noise function for the selected marker and reads the Power Spectral Density.

Key points:

- If current marker under **Marker** menu is off, pressing this key will enable it to Normal type, and then measure the average noise level at the marked point and normalize the value to 1Hz bandwidth. During this process, the system compensates according to different detector modes and trace types. With the mode of “RMS Avg” and “Sample”, the measurement will be more accurate.
- If the **Delta** Function of marker is on, the noise marker will be enabled and moved to the floor noise to be measured, in this case, the readouts shows the Sig./Noise ratio.

9.13. N dB BW

Enable the function of N dB bandwidth measurement or set the value of N dB. The N dB denotes the frequency difference points that are located on both sides of the current marker while the amplitude falls off (N<0) or rises (N>0) N dB separately, see below figure 2-8:

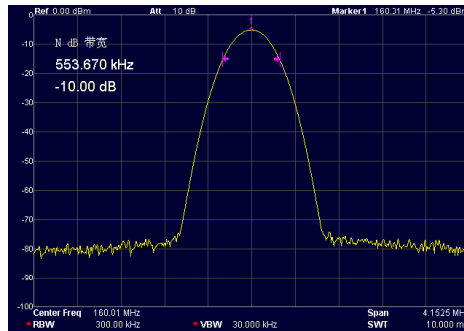

Figure 2-8

Key points:

- After measurement starts, the analyzer first search the two points locate at boths sides of current marker with amplitude difference N dB. If the points are searched, the frequency difference between them will be shown in active area. Or else the sign “---” shows that the search failed.
- You can modify N by numeric keys, knob and arrow keys. For more details, please refer to “**Parameter Input**”.

Table 2-22 N dB BW parameter settings

Parameter	Description
Default	-3 dB
Range	-100 dB ~ 100 dB
Unit	dB
Knob Step	0.1 dB
Arrow Keys Step	1 dB

Function Off

Disable the function of Noise Marker and N dB BW, but not the markers.

9.14. Marker Table

Open or close the marker table. When the table opened, all opened markers are listed on table and shown on the lower window of screen, including Marker number, Marker trace number, readout type, X-axis reading and amplitude. User can watch several measurements of points and up to 8 markers at the same time.

Note:

The opened table can be saved in the external memory and recalled when needed. User can press **Save** key to store the data, detail method is described in "Save".

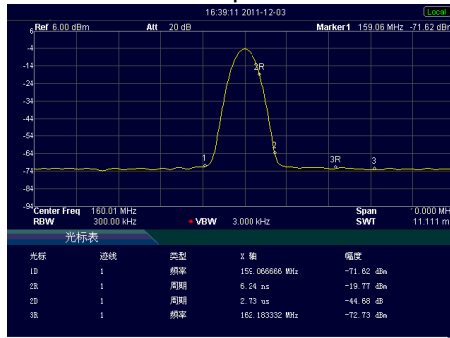

Figure 2-9

9.15. All Off

Turn off all the markers and related functions.

9.16. Freq Count

Frequency counter reading

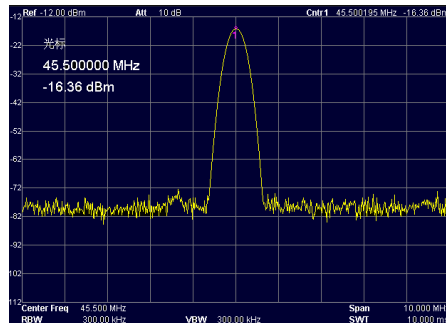

Figure 2-10

1. On/Off

Turn on or off the frequency counter.

Key points:

- If no active marker selected, turning on the frequency counter will open a Normal marker automatically.
- When frequency counter opened, the frequency readouts will be more accurate.
- In Zero span mode, the frequency counter is enabled to measure the frequency of center frequency nearby.

2. Resolution

You can set the resolution of frequency counter by Manual of Auto. The available resolutions are 1 Hz, 10 Hz, 100 Hz, 1 kHz, 10 kHz and 100 kHz.

Table 2-23 The resolution of frequency counter

Parameter	Description
Default	1 kHz
Range	1 Hz ~ 100 kHz
Unit	GHz, MHz, kHz, Hz
Knob Step	10 times
Arrow Keys Step	10 times

10. Peak Search

Open the Peak searching menu and execute the searching function.

Key points:

- If select **Max** in option of **Peak Search**, it will search the maximum on trace and mark it.
- If select **Param** in option of **Peak Search**, it will search and mark the peak that meets the condition of the parameter.
- Next Peak, Peak Right, Peak Left or Peaks in the peak table must meet the specified parameter condition.
- The spurious signal at the zero frequency caused by LO feed will not be taken as Peak.
- If there is no peak meets the specified conditions, the system will prompt message "No peak found".

10.1. Next Peak

Search and mark the peak whose amplitude is the closest to the current peak's and meets the searching condition. If there is no next peak, marker will not move.

10.2. Peak Right

Search and mark the nearest peak on the right of current peak and meets the searching condition. If there is no peak on the right, marker will not move.

10.3. Peak Left

Search the nearest peak on the left of current peak and meets the searching condition. If there is no peak on the left, marker will not move.

10.4. Peak Min

Search and mark the minimum amplitude on trace.

10.5. Peak P-P

Search the Peak and Minimum at the same time, and then mark them by Delta Pair. Peak is marked by Delta and Minimum is marked by Reference.

10.6. Cont Peak

Turn on or off the Continue Search, the default is off. When this type is selected, once sweep finishes, the analyzer will search a peak automatically to trace the measured signal.

The difference between Cont Peak and Signal Track: Cont Peak always search the maximum in current channel, but Signal Track only track the signal with same amplitude of marker before enabling this function, and set the frequency of this signal as center frequency.

10.7. Peak Para

Definite the conditions of peak search for various peak searching. Only for the both satisfaction with “PkExcursion” and “Peak Threshold”, the value can be confirmed as Peak.

1. PK Excursion

Set the delta between the peak and minimum amplitude on both sides of it. Only peak whose delta are beyond the specified delata are treated as desired peak.

Table 2-24 Peak Excursion

Parameter	Description
Default	10 dB
Range	0 dB ~ 200 dB
Unit	dB
Knob Step	1 dB
Arrow Keys Step	1 dB

2. Peak Threshold

Specify the minimum amplitude of peak, only peaks whose amplitude beyond the limit can be treated as desired peak.

Table 2-25 Peak Threshold

Parameter	Description
Default	-90 dBm
Range	-200 dBm ~ 0 dBm
Unit	dBm, -dBm, mV, uV
Knob Step	1 dBm
Arrow Keys Step	1 dBm

3. Peak Search

Set the peak search condition to Maximum or Parameters.

- If **Max** is selected, the system searches the maximum on the trace.
- If **Para** is selected, the system searches the peak meet with specified parameter condition.
- This setting is just available when executing the peak search under Peak menu, while other searches such as Next Peak, Peak Right, Peak Left and Min Search are all based on the Para you specified.

10.8. Peak Table

Open the Peak Table, you will see the peak list that meets the parameter on the lower portion of screen (with frequency and amplitude displayed). The table allows 10 peaks to be shown at most. The opened peak table can be saved in the external memory, also can be recalled when needed. User can press "Save" key to store the data, detail method is described in "Save".

1. On/Off

Turn on or off the Peak Table, the default is Off.

2. Peak Sort

Set Frequency or Amplitude for peak displayed order, the default is Freq.

3. Peak Readout

Set the display condition to Normal, >DL or <DL.

- Normal
Display the first ten peak value meets with the search parameter in table.
- >DL
Display the first ten peak values meet with the search condition and amplitude beyond display level.
- <DL
Display the first ten peak values meet with the search condition and amplitude lower than display level.

11. Marker->

Set the other system parameters (such as frequency, Reference level) using the current marker reading. Press **Marker ->** to enable a marker if none of them are active at present.

11.1. Mkr->CF

Set the center frequency of analyzer to be the frequency of current marker.

- If Normal is selected, the center frequency will be set to the frequency of current marker.
- If Delta, Delta Pair, or Span Pair is selected, the center frequency will be set to the frequency where Delta Marker is.
- In Zero span mode, this function is invalid.

11.2. Mkr->Step

Set the CF step of analyzer to be the frequency of current valid marker.

- If Normal is selected, the CF step will be set to the frequency of current marker.
- If Delta, Delta Pair, or Span Pair is selected, the CF step will be set to the frequency where Delta Marker is.
- In Zero span mode, this function is invalid.

11.3. Mkr->Start

Set the start frequency of analyzer to be the frequency of current valid marker.

- If Normal is selected, the start frequency will be set to the frequency of current marker.
- If Delta, Delta Pair, or Span Pair is selected, the start frequency will be set to the frequency where Delta Marker is.
- In Zero span mode, this function is invalid.

11.4. Mkr->Stop

Set the stop frequency of analyzer to be the frequency of current valid marker.

- If Normal is selected, the stop frequency will be set to the frequency of current marker.
- If Delta, Delta Pair, or Span Pair is selected, the stop frequency will be set to the frequency where Delta Marker is.
- In Zero span mode, this function is invalid.

11.5. Marker Δ ->Span

Set the span of analyzer to be the difference between the two markers in type of of Delta, Delta Pair or Span Pair. In Zero span mode, this function is invalid.

11.6. Mkr->Ref

Set the reference level of analyzer to be the amplitude of current valid marker.

- If Normal is selected, the reference level will be set to the amplitude of current marker.
- If Delta, Delta Pair, or Span Pair is selected, the reference level will be set to the amplitude where Delta Marker is.

12. Auto Tune

Search for signals automatically throughout the whole range and adjust the frequency and amplitude to their best status and realize one-key signal search and auto setting of parameters.

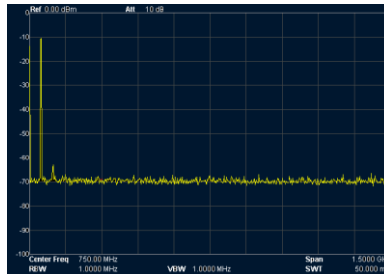

Figure 2-11 Before the Auto Tune

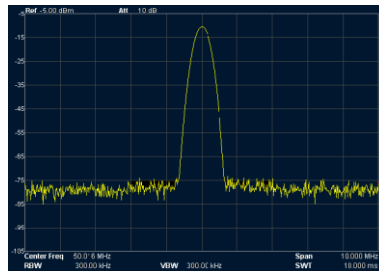

Figure 2-12 After the Auto Tune

Key Points:

- When executing this function, the backlight of Auto is on and “Auto Tune” is shown on the status of screen. Once finish the searching, the backlight will turn off and the icon “Auto Tune” will disappear on status bar.
- In the process, once you press the Auto key, the analyzer will stop the search.
- The parameters such as Reference level, scale, input attenuation and max mixing level will be changed during the searching progress.

13. Display

Control the screen display of the analyzer, such as the display line, full screen, active area and Scr State.

13.1. Display Line

Turn on or off the display line or changes its location, which can be used for reference of readouts or threshold value for the peaks displayed in the peak value.

Key points:

- Display line is a horizontal reference that amplified is equal to specified value, the amplitude unit of which is same as the one of Y-axis.
- You can adjust the display line by numeric keys, knob and arrow keys.

13.2. Full Screen

Switch to full screen state, the menus on right of screen and the parameters on the left of screen will both disappear.

Pressing this key again will exit the full screen state and easy for user to watch the detail trace information.

13.3. Active Fctn

Select the position in which the active function is displayed for convenient view of the trace.

Optional is Top, Center, Bottom, the default is Top.

13.4. Screen Off

Turn on or off the display, the default is On.

14. Preset

When this key pressed, the system will return to Factory settings or user defined state.

15. System Setup

Set the parameters on system.

15.1. Language

Select Chines or English for display language.

15.2. Reset

The function includes: select the instrument setting (Last or Preset) to be recalled after the analyzer is powered on. Set the type for Preset ("Factory Setting" or User Defined). Save the system setting.

1. Power On

Set the power on setting to Last or Preset

- If Last is selected, settings before ths last power-off will be recalled when power on.
- If Preset is selected, settings defined in the Preset Type will be recalled when power on.

2. Preset Type

Select the preset type to "Factory Setting" (default) or "User-defined".

- If select the power on for preset, the analyzer will recall the preset when power on.
- After power on, you can press **Preset** key to recall the specified Preset Type under any operation menu.

3. Save Preset

Save the current instrument settings.

15.3. I/O Settings

The analyzer supports communication through the LAN, USB and RS232 interface.

1. I/O interface

Enable the LAN, USB and RS232, or disable them all.

2. LAN

Set the information for LAN.

3. USB

Set the information for USB.

4. RS232

Set the information for RS232

15.4. Ref Source

Select the internal or external reference source, the default is internal.

16. Measure

The analyzer provides advanced measurement functions including Channel Power, Adjacent Channel Power and Occupied Bandwidth.

16.1. Channel Power

Measures the total power of signal within the specified channel bandwidth, which includes the Channel Power and Power Density.

Channel power: the power within the integral bandwidth

Power Density: the power normalized to 1Hz within the integral bandwidth.

Select **Channel Power** measurement under **Meas** function and press **Meas Setup** to set corresponding parameters.

16.2. Integ BW

Specify the range of integration used in calculating the power in the channel

16.3. Limit

Set the level for Channel Power and Power Density measurements.

Press **Limit** key to display the status of Level, including the Total Level, Channel Power Level and Power Density Level. Default is Off. Only enable the Total Level, the Channel Power Level and Power Density Level will be displayed.

If you want to set the Level Parameters for Channel Power measurements, first make the Channel Power Level to be On, there will be two options Power Max and Power Min.

CP Max : set the maximum of level

CP Min : set the minimum of level

For example, to measure a transmitter module with the power channel ranges from - 10dBm to 0dBm, you can set the max. power to be 0dBm and min. power to be -10dBm.

The setting for Power Density Level parameters is same.

16.4. Adjacent Channel Power (ACP)

Measures the powers of the main channel and adjacent channels as well as the power difference between the main and each of the adjacent channels. The adjacent channels have same channel bandwidth with the main channel, or set user's demand.

Select **ACP** measurement under **Meas** function and press **Meas Setup** to set corresponding parameters, which includes Integ BW, Offset/Limits, Meas Type, Total Pwr Ref and Limits.

16.5. Integ BW

Sets the bandwidth for main channel

16.6. Offset/Limits

Includes Offset, Offs Freq, Ref BW, Neg Limits, Pos Limits, En.

Offset	selects one to six adjacent channels.
Offs Freq	sets the frequency of offset carrier
Ref BW	sets the bandwidth for adjacent channels
Neg Limits	sets the threshold parameters for left adjacent channels
Pos Limits	sets the threshold parameters for right adjacent channels
En:	opens or closes the adjacent channels from one to six channels

16.7. Meas Type

Selects measurements type as **Total Pwr Ref** or **PSD Ref**. Default is Total Pwr Ref.

16.8. Total Pwr Ref

Sets total power reference to be Manual or Auto

Auto the total power reference is set automatically

Manual the total power reference is set manually

16.9. Occupied Bandwidth (OBW)

Calculates the power within the whole bandwidth by integral operation and computes the occupied bandwidth by this value based on the specified power ratio. Default occupied bandwidth percentage is 99%.

Select **OBW** measurement under **Meas** function and press **Meas Setup** to set corresponding parameters, which includes Max Hold, % Pwr, OBW Span, n dB and Limits.

16.10. Max Hold:

Enables or disables the Max Hold, default is Off. When enabled, the function of which is same as the one of Trace.

16.11. % Pwr :

Sets the occupied bandwidth percentage, that is the percentage of signal power occupied within integral bandwidth power.

OBW Span:

Sets the integral frequency range in main channel, span will be set as the integral bandwidth

16.13. n dB:

Sets the n dB value for calculates the transmitting bandwidth

16.14. Limits:

The menu includes OBW, CW Offs and ACP

16.15. OBW:

Sets the limitation to Occupied Bandwidth

16.16. CW Offs:

Sets the limitation to frequency offset

16.17. Chain Pwr:

Sets the limitation to channel power

Chapter 3 Remote control

Users can control this series of digital Spectrum Analyzers through USB, LAN and RS-232 remote interface. This chapter introduces the basic information and method of remote control of the instrument.

The contents of this chapter are as follows:

- Remote control overview (refer to the Spectrum Analyzer software instructions)
- Remote control method (refer to the Spectrum Analyzer software instructions)

17. Specifications

17.1. Frequency

17.1.1. Frequency Range

Range	P 4130-1	9kHz to 1.5GHz
	P 4135-1	9kHz to 2.2GHz
	P 4140-1	9kHz to 3.0GHz
Resolution		1Hz

17.1.2. Internal reference frequency

Reference frequency	10MHz
Aging rate	$<5 \times 10^{-6}$ /year
Temperature stability	$<5 \times 10^{-6}$ (20 °C to 30 °C)

17.1.3. Frequency reading precision

Cursor frequency resolution	span/ (sweep points-1)
Cursor frequency uncertainty	\pm (cursor frequency reading \times reference frequency uncertainty+1% \times span+10% \times resolution bandwidth+ cursor frequency resolution)

17.1.4. Frequency counter

Counter resolution	1Hz, 10Hz, 100Hz, 1kHz, 10kHz, 100kHz
Counter uncertainty	\pm (cursor frequency reading \times reference frequency uncertainty+counter resolution)

Note:

Frequency reference uncertainty= (aging rate \times period since adjustment + temperature shift)

17.1.5. Frequency span

Range	P 4130-1	0Hz, 100Hz to 1.5GHz
	P 4135-1	0Hz, 100Hz to 2.2GHz
	P 4140-1	0Hz, 100Hz to 3.0GHz
Uncertainty		\pm span/ (sweep points-1)

17.1.6. SSB Phase Noise

Carrier offset	<-80 dBc/Hz (@10 kHz, $f_c < 1.0$ GHz)
----------------	--

17.1.7. Bandwidth

Resolution bandwidth (-3dB)	10Hz to 1MHz, step is 1-3-10; 9kHz, 120kHz
RBW precision	$<5\%$, nominal value
Resolution filter shape factor (60dB: 3dB)	<5 , nominal value
Video bandwidth (-3dB)	1Hz to 1MHz, step is 1-3-10

17.2. Amplitude

17.2.1. Measurement range

Range	P 4130-1	10MHz to 1.5GHz DANL to +30 dBm
	P 4135-1	10MHz to 2.2GHz DANL to +30 dBm
	P 4140-1	10MHz to 3.0GHz DANL to +30 dBm

17.2.2. Maximum input level

DC voltage	50V
Continuous wave RF power	+30dBm (1.0 W)
Maximum damage level	+40dBm (10W)

17.2.3. DANL

0 dB attenuation, RBW=VBW=100 Hz, sample detector, trace average≥ 50		
Display Average Noise Level (preamplifier off)	100kHz to 10MHz	-90dBm, typical value-110dBm
	10MHz to 1.5GHz (P4130-1)	-120dBm+6 x (f/1GHz)dB, typical value -125dBm
	10MHz to 2.2GHz (P4135-1)	
	10MHz to 3.0GHz (P4140-1)	
Display Average Noise Level (preamplifier on)	100 kHz to 30MHz	- 90dBm, typical value -110dBm
	30MHz to 1.5GHz (P4130-1)	-135dBm+6 x (f/1GHz)dB, typical value -140dBm
	30MHz to 2.2GHz (P4135-1)	
	30MHz to 3.0GHz (P4140-1)	

17.2.4 Display level

Logarithm scale	1dB to 200dB
Linear scale	0 to reference level
Number of display points	601
Numbers of traces	3+ arithmetical trace
Detection modes	positive peak, negative peak, sample detection, standard detection, RMS, average voltage
Trace functions	Clear write, max hold, min hold, average, view, close
Scale unit	dBm, dBmV, dBμV, V, W

17.2.5. Frequency response

10dB attenuation, relative to 50MHz, 20°C to 30°C		
Frequency response (preamplifier off)	1.0MHz to 1.5GHz (P4130-1)	±1.0dB
	1.0MHz to 2.2GHz (P4135-1)	
	1.0MHz to 3.0GHz (P4140-1)	
Frequency response (preamplifier on)	50MHz to 1.5GHz (P4130-1)	±1.0dB
	50MHz to 2.2GHz (P4135-1)	
	50MHz to 3.0GHz (P4140-1)	

17.2.6. Input attenuation error

Setting range	0 to 50dB, step is 1dB
Switch uncertainty	fc=50 MHz, relative to 10dB, 20°C to 30°C <0.5dB

17.2.7. Resolution bandwidth switch

Uncertainty	100Hz to 1MHz, relative to RBW 1kHz	±0.15dB
-------------	-------------------------------------	---------

17.2.8. Reference level

Range	-100dBm to +30dBm, step is 1dB	
Resolution	logarithm scale	0.01dB
Linear scale	4 digits	

17.2.9. Full-amplitude precision

Full-amplitude precision	95% confidence level, S/N>20dB, RBW=VBW=1 kHz, Pre-amplifier is closed, 10dB attenuation, -10dBm<reference level<0, 10MHz<fc<3.0GHz, within 20 °C to 30 °C ±1.0dB, nominal value
--------------------------	---

17.2.10. Intermodulation

Second Harmonic Intercept (SHI)	+40dBm
Third-order intermodulation (TOI) fc>30MHz	+10dBm

17.2.11 Spurious responses

Image frequency	<-60dBc
Intermediate frequency	<-60dBc
Residual response, intrinsic	<-80dBm, typical value
Residual response, other: Local oscillators, A/D conversion, subharmonic of first LO, harmonic of first LO	<-60dBc
Input related spurious Mixer level: -30dBm	<-60dBc, typical value

17.3. Sweep

17.3.1 Sweep

Sweep time range	P4130-1	100Hz ≤span≤ 1.5GHz ; Zero span 10ms to 1500s
	P4135-1	100Hz ≤span≤ 2.2GHz ; Zero span 10ms to 2200s
	P4140-1	100Hz ≤span≤ 3.0GHz ; Zero span 10ms to 3000s
Sweep time precision	P4130-1	100Hz ≤span≤ 1.5GHz ; 5%, nominal value
	P4135-1	100Hz ≤span≤ 2.2GHz ; 5%, nominal value
	P4140-1	100Hz ≤span≤ 3.0GHz ; 5%, nominal value
Zero span	0.5%, nominal value	
Sweep mode	Continuous, single	

17.4. Trigger

17.4.1 Trigger

Trigger source	free, video, external
External trigger level	5V TTL level

17.5. Input/output

17.5.1. RF input

Impedance	50Ω
Connector	N female

17.5.2. Tracking source output

Impedance	50Ω
Connector	N female

17.5.3. 10MHz reference input/10MHz reference output/external trigger input

Connector	BNC female
10MHz reference input amplitude	0dBm to +10dBm
10MHz reference output amplitude	-3dBm to +3dBm
Trigger voltage	5V TTL level

17.6. General characteristics

17.6.1 Display:

Display type:	TFT LCD
Display resolution:	800*480 Pixels
Screen:	7.0 inch

17.6.2. Remote interface:

Standard interface:	LAN, USB Host, USB Device, RS232
---------------------	----------------------------------

17.6.3. Power:

Input voltage:	100V to 240V, nominal AC
Power consumption:	35W
AC range:	45Hz to 440Hz

17.6.4. Temperature

Working temperature:	5°C to 40°C
Storage temperature:	-20°C to 70°C

17.6.5 .Dimension

Width x High x Length:	363mm×154mm×327mm
------------------------	-------------------

17.6.6. Weight:

Weight (Device only)	6.0kg
----------------------	-------

Chapter 4: Appendix

Standard accessories:

CD- ROM with User's Guide and Programmers Guide
BNC-BNC cable
N-BNC adapter
N-SMA cable
N-SMA adapter
Power cord

High stability oscillator

Reference frequency	10MHz
Aging rate	$<5 \times 10^{-7}$ /year
Temperature stability	$<5 \times 10^{-7}$ (20 °C to 30 °C)

All rights, also for translation, reprinting and copy of this manual or parts are reserved.

Reproduction of all kinds (photocopy, microfilm or other) only by written permission of the publisher.

This manual considers the latest technical knowing. Technical changes which are in the interest of progress reserved.

We herewith confirm, that the units are calibrated by the factory according to the specifications as per the technical specifications.

We recommend to calibrate the unit again, after one year.

© **PeakTech**® 03/2017/MP