

QR series



QR30-090B-VK

Absolute rotary encoder (contactless)

Output
0 - 5 V

Supply voltage
10 - 30V dc

Measuring range
90° (out of 360°)



General specifications 10056, v20130826	
Housing	Quadro30: PBT black
Dimensions	30x30x15 mm
Mounting	2x steel zinc plated M3x16 mm screws
Ingress Protection (IEC 60529)	IP67
Weight	approx 15 gr (excl. cable)
Magnet type	8x5,5x11,2 mm Neodymium/N35/nickel coated/remanention 1,2 T
Magnet distance to sensor	0,5 to 3 mm
Max magnet misalignment	± 0,25 mm off axis
Direction of magnetization	Axial in 8 mm (N marked with red dot)
Supply voltage	10 - 30V dc
Polarity protection	Yes
Current consumption	≤ 25 mA
Operating temperature	-25 to 85°C
Storage temperature	-25 to 85°C
Measuring range	90° (out of 360°)
Programmable center position	No
Accuracy	
Resolution	10 bit f.s. (min step 0,35°)
Max offset error	Not applicable
Non linearity	< ± 1,4° (in magnet alignment range)
Repeatability	0,47°
Response time	< 10 ms
Max speed	15 rpm
Output signal	0 - 5 V
Short circuit protection	Yes (max 10 s)
Output load resistor	≥ 20 kΩ
Connection	Cable 2 m PVC/PVC Liyy, black Ø 4,6 mm, wires: 3x0,34 mm² Sensor colors (static usage)
Wire coding	Brown + Supply voltage Black Output Blue Gnd

QR30-090B-VK

Transfer characteristic

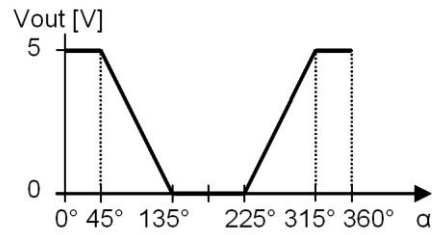

QR30-090B-VK

Dimensions

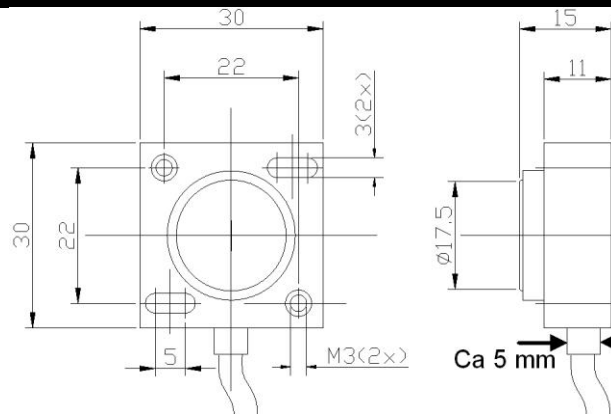

QR30-090B-VK

Application example

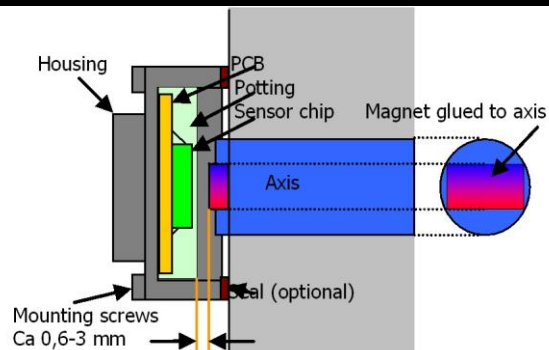

QR30-090B-VK

The magnet is drawn in the 0° position.
 90° position: N pole towards cable.
 The north pole is indicated with a red dot.

Magnet position

